

The power behind competitiveness

# Delta UPS - Amplon Family

RT Series, Single Phase  
5/ 6/ 8/ 10 kVA

User Manual

[www.deltapowersolutions.com](http://www.deltapowersolutions.com)

 **DELTA**  
Smarter. Greener. Together.

## SAVE THIS MANUAL

This manual contains important instructions and warnings that you should follow during the installation, operation, storage and maintenance of this product. Failure to heed these instructions and warnings will void the warranty.

Copyright © 2019 by Delta Electronics Inc. All Rights Reserved. All rights of this User Manual (“Manual”), including but not limited to the contents, information, and figures are solely owned and reserved by Delta Electronics Inc. (“Delta”). The Manual can only be applied to the operation or the use of this product. Any disposition, duplication, dissemination, reproduction, modification, translation, extraction, or usage of this Manual in whole or in part is prohibited without the prior written permission of Delta. Given that Delta will continuously improve and develop the product, changes may be made to the information in this Manual at any time without obligation to notify any person of such revision or changes. Delta will make all possible efforts to secure the accuracy and the integrity of this Manual. Delta disclaims any kinds or forms of warranty, guarantee, or undertaking, either expressly or implicitly, including but not limited to the completeness, faultlessness, accuracy, non-infringement, merchantability or fitness for a particular purpose of the Manual.

# Table of Contents

<b>Chapter 1 : Important Safety Instructions</b>	<b>1</b>
1.1 Safety Instructions	1
1.2 Standard Compliance	4
1.3 Storage	4
<b>Chapter 2 : Introduction</b>	<b>5</b>
2.1 General Overview	5
2.2 Exterior & Dimensions	5
2.3 Package List	6
<b>Chapter 3 : Operation Panel</b>	<b>8</b>
3.1 LED Indicators	8
3.2 Multi-function Buttons	9
3.3 LCD Display	12
3.3.1 Icon/ Display Definition	13
3.3.2 Operation Mode Diagram Definition	14
<b>Chapter 4 : Rear Panel</b>	<b>16</b>
<b>Chapter 5 : Communication Interfaces</b>	<b>19</b>
5.1 MINI Slot	19
5.2 Parallel Ports	19
5.3 Dry Contacts	19
5.4 REPO Port	19
5.5 RS-232 Port	20
5.6 USB Port	21
5.7 RS-485 Port	21
5.8 External Battery Connector	22
<b>Chapter 6 : Installation</b>	<b>25</b>
6.1 Rack Mounting	25
6.2 Tower Mounting	27
<b>Chapter 7 : Connection and Wiring</b>	<b>29</b>

7.1	UPS Connection Warnings-----	29
7.2	Input/ Output Connection -----	29
7.3	Single Unit Wiring-----	32
7.4	Parallel Units Wiring -----	33
7.5	External Battery Pack Connection-----	34
<b>Chapter 8 : Operation -----</b>		<b>36</b>
8.1	Single Unit Start-up -----	36
8.1.1	Start-up with AC Input (Single Unit)-----	36
8.1.2	Start-up with Batteries (Single Unit)-----	37
8.2	Single Unit Turn-off-----	38
8.3	Parallel Units Start-up -----	39
8.3.1	Start-up with AC Input (Parallel Unit) -----	39
8.3.2	Start-up with Batteries (Parallel Unit)-----	40
8.4	Parallel Units Turn-off-----	40
8.5	Operation Mode -----	41
<b>Chapter 9 : LCD Display &amp; Settings -----</b>		<b>42</b>
9.1	Initial Setting Screen-----	42
9.2	Main Menu-----	44
9.2.1	Measurement Menu-----	47
9.2.2	Setting Menu-----	47
9.2.3	Control Menu -----	53
9.2.4	Maintenance Menu-----	55
<b>Chapter 10 : Optional Accessories -----</b>		<b>60</b>
<b>Chapter 11 : Troubleshooting-----</b>		<b>61</b>
<b>Chapter 12 : Maintenance-----</b>		<b>63</b>
12.1	UPS -----	63
12.2	Batteries-----	63
12.3	Fans-----	64
<b>Appendix 1 : Technical Specifications-----</b>		<b>65</b>
<b>Appendix 2 : Warranty -----</b>		<b>67</b>

# Chapter 1 : Important Safety Instructions

## 1.1 Safety Instructions

### Installation Warnings





- Before installation and usage, please read this **User Manual** thoroughly. This helps you to use the product correctly and safely.
- Install the UPS in a well-ventilated area, away from excess moisture, heat, dust, flammable gas or explosives.
- To avoid fire accidents and electric shock, please install the UPS in a temperate and humidity well-controlled indoor area free of conductive contaminants. For the temperature and humidity specifications, please refer to **Appendix 1 : Technical Specifications**.
- Leave adequate space (at least 50cm) around all sides of the UPS for proper ventilation.

### Connection Warnings

- The UPS must be well grounded due to a possible risk of current leakage.
- The installation of upstream and downstream protective devices is highly recommended when the UPS is connected to the mains and the loads.
- The protective devices connecting to the UPS must be installed near the UPS and must be easily accessible for operation.
- If you need to move the UPS or perform re-wiring, please turn off the AC input power and ensure that the UPS has been safely shutdown. Otherwise, the output end might still be energized, which might cause electric shock.

### Usage Warnings

- This is a class-A product. In a domestic environment, this product may cause radio interference, in which case, the user is required to take adequate measures.
- The UPS can be used to power computers and associated peripheral devices, such as monitors, modems, cartridge tape drives, external hard drives, etc.



- It is strictly forbidden to connect the UPS with:
  1. Any regenerative loads.
  2. Any asymmetrical loads.
- To ensure reliable operation of the UPS and to protect the UPS from overheating, the slits and openings in the UPS must not be blocked or covered.
- Before usage, you must allow the UPS to adjust to room temperature for at least one hour to avoid moisture condensing inside the UPS.
- Do not pour and splash any liquid on the UPS. Do not insert any object into the UPS's slits and openings. Do not put beverage containers on or around the UPS.
- When an emergency occurs, (1) press and hold the **ON/ OFF** button () for 3 seconds, (2) release it after you hear one beep, (3) use the Scrolling UP or Down button ( / ) to select 'Yes', and (4) press the Enter button () to confirm your selection to turn off the UPS. After that, cut off the input power to completely shut down the UPS. Cut off the input power to completely shut down the UPS.
- Do not use any cleaning liquid or cleaning spray to clean the UPS. Before cleaning, please make sure that the UPS has been completely shut down, the UPS's input power has been cut off, and the batteries have been disconnected.
- All maintenance services must be performed by qualified service personnel.
- Forbid opening or removing the cover of the UPS yourself to avoid high voltage electric shock.
- You must contact qualified service personnel if either of the following events occurs:
  1. Liquid is poured or splashed on the UPS.
  2. The UPS does not run normally after this **User Manual** is carefully observed.



**NOTE :**

If you use the UPS in an area that generates or incurs dust, you should install two dust filters (optional) in the 5/ 6/ 8/ 10kVA UPS to ensure normal product life and function.

### **Battery Warnings**

- Keep the batteries away from heat sources. Do not open or mutilate the batteries.
- Do not dispose of batteries in a fire. The batteries may explode.
- The released electrolyte is harmful to the skin and eyes and may be toxic.
- A battery can present a risk of electric shock and high short-circuit current.
- Servicing of batteries and battery packs must be performed or supervised by qualified service personnel knowledgeable in batteries, battery packs and the required precautions. Keep unauthorized personnel away from batteries and battery packs.
- The risk of electric shock and short-circuit current is possible when the batteries are connected to the UPS. Before maintenance, disconnect all batteries to cut off the battery power.
- For battery replacement, only use the same number and type of batteries.
- Observe the following before replacing the batteries:
  1. Remove watches, rings, or other metal objects.
  2. Use tools with insulated handles.
  3. Wear rubber gloves and boots.
  4. Do not lay tools or metal parts on the top of batteries.
  5. Disconnect charging source prior to connecting or disconnecting battery terminals.
  6. Remove battery grounds during installation and maintenance to reduce likelihood of shock. Remove the connection from ground if any part of the battery is determined to be grounded.
- Do not connect the batteries in reverse; otherwise, a risk of electric shock or fire accidents might occur.
- The batteries might lose their power during shipment or storage. Before you use the UPS for the first time, please fully charge the batteries until the battery capacity percentage shown on the UPS's LCD is 100% (). If the UPS needs to be stored for an extended period of time, please charge the batteries every three months and ensure that, every time after charging, the battery capacity percentage shown on the UPS's LCD is 100% (.



### **WARNING:**

1. The risk of electric shock and short-circuit current is possible when the batteries are still connected to the UPS even though the UPS is disconnected from the mains. Do not forget to cut off the battery source before maintenance.
2. When the UPS is connected to external battery packs, the installation of appropriate protective devices, such as a DC fuse or a DC non-fuse breaker, is required.

## **1.2 Standard Compliance**





- CE
- EN 62040-1
- UL, cUL
- EN 62040-2 Category C2

## **1.3 Storage**

### **• Prior to installation**

If the UPS needs to be stored prior to installation, it should be placed in a dry and well-ventilated area. The allowable storage temperature is between -15°C and +50°C (5°F~122°F).

### **• After usage**

(1) Press and hold the ON/OFF button () for 3 seconds, (2) release it after you hear one beep, (3) use the Scrolling UP or Down button ( / ) to select 'Yes', and (4) press the Enter button () to confirm your selection to turn off the UPS. Make sure the UPS is shutdown, disconnect the UPS from the utility AC power, remove all loads/ equipment from the UPS, and store the UPS in a dry and well-ventilated area at a temperature between -15°C and +50°C (5°F~122°F).

Idle batteries must be recharged fully approximately every three months if the UPS needs to be stored for an extended period of time. Ensure that, every time after charging, the battery capacity percentage shown on the UPS's LCD is 100% () .



### **NOTE :**

After storage and before start-up of the UPS, you must allow the UPS to adjust to room temperature (20°C~25°C or 68°F~77°F) for at least one hour to avoid moisture condensing inside the UPS.



## Chapter 2 : Introduction

### 2.1 General Overview

The RT series UPS is a single-phase input, single-phase output on-line uninterruptible power supply which provides reliable and consistent sine-wave quality power to your electronic equipment. It adopts the latest technology and the highest quality components providing output power factor up to unity, and its efficiency in on-line mode reaches up to 96%. The UPS not only provides safe, reliable and uninterruptible power to your sensitive electronic equipment at all times, but also produces greater electronic power efficiency at less cost. There are four different ratings, 5kVA, 6kVA, 8kVA and 10kVA, for your selection.

### 2.2 Exterior & Dimensions

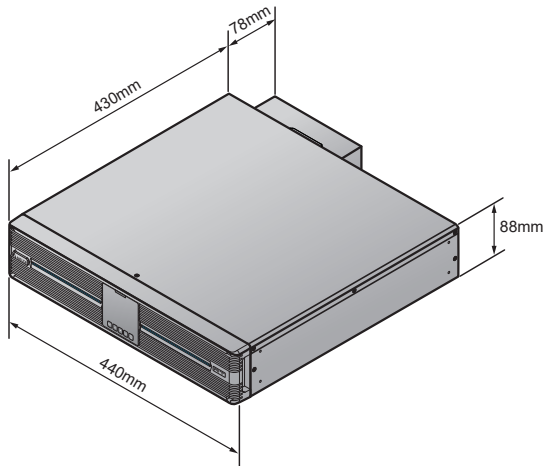

(Figure 2-1: Extended Runtime Model - 5/6KVA Exterior & Dimensions)

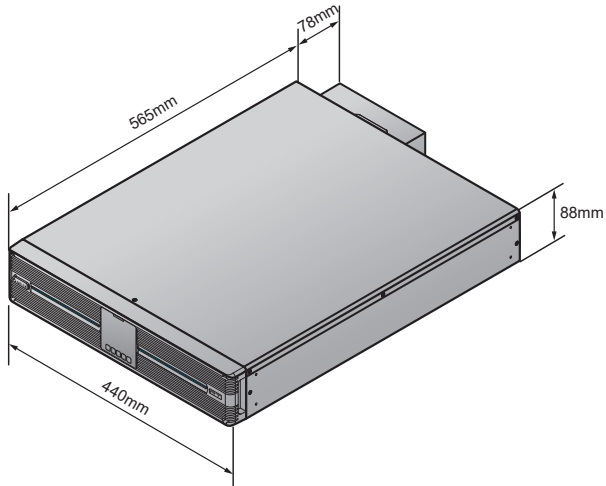

(Figure 2-2: Extended Runtime Model - 8/ 10KVA Exterior & Dimensions)

## 2.3 Package List

The package contains the following items. Please check if any item is missing. If there is anything missing, please contact the dealer immediately.

### Models:

**UPS502R2RT2N035 & UPS502R2RT2N0B0 & UPS502R2RT2N0B8 &  
 UPS602R2RT2N035 & UPS602R2RT2N0B0 & UPS602R2RT2N0B8 &  
 UPS802R2RT2N035 & UPS802R2RT2N0B0 & UPS802R2RT2N0B8 &  
 UPS103R2RT2N035 & UPS103R2RT2N0B0 & UPS103R2RT2N0B8**

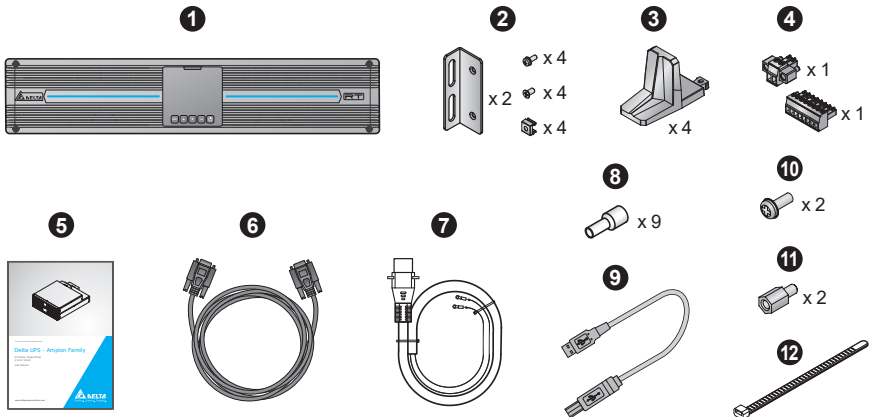

No.	Item	5/ 6/ 8/ 10kVA
①	UPS	1 PC
②	Bracket Ear for UPS	1 SET
③	Tower Stand	4 PCS
④	Pluggable Terminal	2 PCS
⑤	User Manual	1 PC
⑥	Parallel Cable	1 PC
⑦	Battery Cable	1 PC
⑧	Cord End Terminal	9 PCS
⑨	USB Cable	1 PC
⑩	Screw (for fixing the battery cable)	2 PCS
⑪	Standoff (for fixing the battery cable)	2 PCS
⑫	Cable Tie	6 PCS

**NOTE :**

1. If there is any damage or anything missing, please immediately contact the dealer from whom you purchased the unit.
2. If the UPS needs to be returned, carefully repack the UPS and all of the accessories using the original packing material that came with the unit.

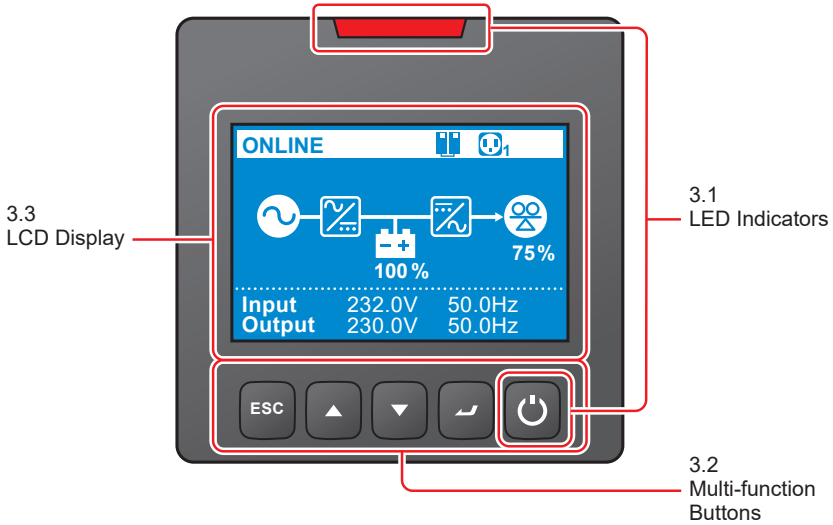

# Chapter 3 : Operation Panel

On the front panel of the UPS, you'll see two LED indicators, a LCD display, and multi-function buttons.













(Figure 3-1: Operation Panel)



## 3.1 LED Indicators

No.	LED	Description
1		<ol style="list-style-type: none"> <li><b>ON:</b> The output is protected.</li> <li><b>OFF:</b> The output is not protected.</li> </ol>
2		<ol style="list-style-type: none"> <li><b>ON:</b> The UPS detects an internal fault or an environmental fault.</li> <li><b>OFF:</b> The UPS is in normal state.</li> <li><b>Flashing:</b> The UPS shows the warning message(s). Please check the corresponding warning message(s) in <b>Chapter 11: Troubleshooting</b>.</li> </ol>

## 3.2 Multi-function Buttons

No.	Multi-function Button	Description
1	 <p><b>ON/ OFF Button</b></p>	<p>The button has multiple functions. Please refer to the following for detailed information.</p> <p><b>1. Turn-on</b></p> <ul style="list-style-type: none"> <li>• In standby/ bypass mode, press and hold the button for 3 seconds, release it after you hear one beep and the UPS will run in on-line mode.</li> <li>• Cold start: When there is no AC input, press and hold the button for 3 seconds, release it after you hear one beep and the UPS will run in battery mode.</li> </ul> <p><b>2. Turn-off</b></p> <ul style="list-style-type: none"> <li>• In on-line mode, (1) press and hold the button for 3 seconds, (2) release it after you hear one beep, (3) use the Scrolling UP or Down button (  /  ) to select 'Yes', and (4) press the Enter button (  ) to confirm your selection. After that, the inverter will be off and the UPS will transfer to run in standby or bypass mode.</li> </ul> <p>The UPS will keep charging the batteries when the UPS is in standby/ bypass mode. To fully turn off the UPS, it is advised to disconnect the UPS from the AC power.</p> <ul style="list-style-type: none"> <li>• In battery mode, (1) press and hold the button for 3 seconds, (2) release it after you hear one beep, (3) use the Scrolling UP or Down button (  /  ) to select 'Yes', and (4) press the Enter button (  ) to confirm your selection. After that, the UPS will be turned off.</li> </ul> <p><b>3. Fault Clear</b></p> <p>When the UPS has a fault condition, press and hold the button for 3 seconds, release it after you hear one beep and the UPS will try to clear the fault condition.</p>

No.	Multi-function Button	Description
1	 <p><b>ON/ OFF Button</b> (Continued)</p>	<p> <b>NOTE:</b></p> <ol style="list-style-type: none"> <li>1. When the UPS clears the fault condition, it means that the buzzer/ warning message has been turned off. To eliminate the fault detected, please refer to <b>Chapter 11: Troubleshooting for relevant solutions</b>.</li> <li>2. The function mentioned above is only applicable to the condition when the UPS has a fault situation and the inverter is off.</li> </ol>
2	 <p><b>Enter Button</b></p>	<p>The button has multiple functions. Please refer to the following for detailed information.</p> <p><b>1. Entering into the setup mode</b></p> <p>In the <b>Main Screen</b> (that shows the current operation mode), press the button for 0.1 second and the UPS will enter the <b>Main Menu</b> (setup mode). Please refer to <b>Chapter 9: LCD Display &amp; Settings</b>.</p> <p><b>2. Selecting and confirming the parameter in setup mode</b></p> <p>In setup mode, press the button to choose the parameter you want to change, and the parameter will flash. Press the <b>Scrolling Up</b> or the <b>Scrolling Down</b> button to change the parameter and press the button again to confirm the change.</p>
3	 <p><b>Scrolling Up Button</b></p>	<p>The button has multiple functions. Please refer to the following for detailed information.</p> <p><b>1. Scrolling Up/ Increasing Number</b></p> <ul style="list-style-type: none"> <li>• In the <b>Main Screen</b>, press the button for 0.1 second and the UPS will directly enter the <b>Measurement Menu</b>'s level 3 (see <b>Figure 9-1: Menu Tree</b>), which contains related <b>Output</b> information.</li> <li>• In setup up mode, the button is used to navigate the setting items. Press the button for 0.1 second to go to the previous setting item.</li> </ul>

No.	Multi-function Button	Description
3	 <p><b>Scrolling Up Button</b> (Continued)</p>	<ul style="list-style-type: none"> <li>The button is also used to navigate or set up the setting parameter. Press the button for 0.1 second to go to the previous display or to increase a number. If the button is pressed for more than 2 seconds, the number will be increased single digit every 0.2 second automatically until the button is released or the number reaches its highest value.</li> </ul> <p><b>2. LCD Reset</b></p> <ul style="list-style-type: none"> <li>Press the <b>Scrolling Up</b> and the <b>Scrolling Down</b> buttons together for 3 seconds to reset the LCD display.</li> </ul>
4	 <p><b>Scrolling Down Button</b></p>	<p>The button has multiple functions. Please refer to the following for detailed information.</p> <p><b>1. Scrolling Down/ Decreasing Number</b></p> <ul style="list-style-type: none"> <li>In the <b>Main Screen</b>, press the button for 0.1 second and the UPS will directly enter the <b>Measurement Menu</b>'s level 3 (see <b>Figure 9-1: Menu Tree</b>), which contains related <b>Output</b> information.</li> <li>In setup up mode, the button is used to navigate the setting items. Press the button for 0.1 second to go to the next setting item.</li> <li>The button is also used to navigate or set up the setting parameter. Press the button for 0.1 second to go to the next display or to decrease a number. If the button is pressed for more than 2 seconds, the number will be decreased single digit every 0.2 second automatically until the button is released or the number reaches its lowest value.</li> </ul> <p><b>2. LCD Reset</b></p> <ul style="list-style-type: none"> <li>Press the <b>Scrolling Up</b> and the <b>Scrolling Down</b> buttons together for 3 seconds to reset the LCD display.</li> </ul>

No.	Multi-function Button	Description
5	 <p>Back/ Mute Button</p>	<p>The button has multiple functions. Please refer to the following for detailed information.</p> <ol style="list-style-type: none"> <li><b>1. Back to the Previous Menu Level</b> <ul style="list-style-type: none"> <li>• In setup mode, press the button for 0.1 second to go back to the previous menu level.</li> </ul> </li> <li><b>2. Mute</b> <ul style="list-style-type: none"> <li>• When the UPS has any warning of fault conditions to trigger an audible alarm, press and hold the button for 3 seconds to turn off the audible alarm.</li> </ul> </li> </ol>



**NOTE:**





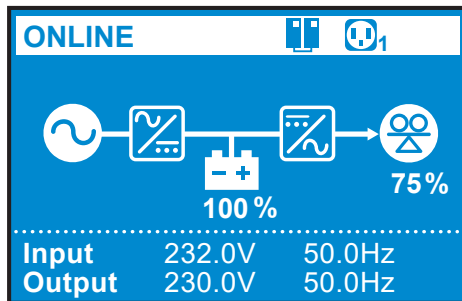











If the LCD display goes dim, press any button mentioned above for 0.1 second to wake up the LCD display and enable each button function.

### 3.3 LCD Display











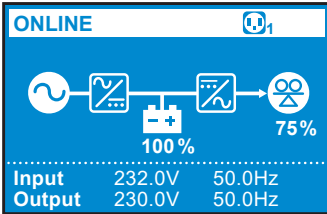

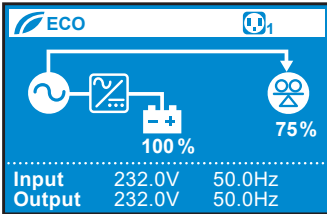

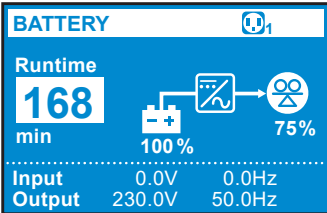

### 3.3.1 Icon/ Display Definition

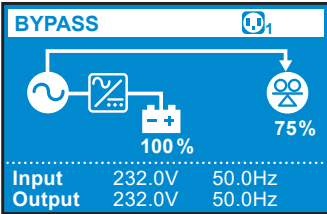
No.	Icon/ Display	Description						
1		<p>1. <b>ON:</b> The UPS is in parallel mode.</p> <p>2. <b>OFF:</b> The UPS is in single mode.</p> <p> <b>NOTE:</b> For the Master UPS, the icon will flash during parallel mode. For the Slave UPS, the icon will illuminate, not flash, during parallel mode.</p>						
2		Indicates that the load bank status is ON.						
		Indicates that the load bank status is OFF.						
3		Indicates the battery capacity level.						
		Indicates that the battery is abnormal and needs replacement. If the battery is abnormal, the battery capacity icon (  ) will be off.						
4		Indicates the load level (%).						
5	<table border="1" data-bbox="182 1010 440 1058"> <tr> <td>Input</td> <td>232.0V</td> <td>50.0Hz</td> </tr> <tr> <td>Output</td> <td>232.0V</td> <td>50.0Hz</td> </tr> </table>	Input	232.0V	50.0Hz	Output	232.0V	50.0Hz	When the UPS runs normally, the display will show the input/ output voltage and frequency.
	Input	232.0V	50.0Hz					
Output	232.0V	50.0Hz						
<table border="1" data-bbox="182 1153 440 1241"> <tr> <td> 0x1003</td> <td rowspan="2" style="text-align: center; vertical-align: middle;">  5 seconds                 </td> </tr> <tr> <td>Battery disconnected</td> </tr> </table>	 0x1003	 5 seconds	Battery disconnected	<p>When the UPS has abnormalities or is in fault condition, the display will show an error code and its corresponding fault or warning message.</p> <p> <b>NOTE:</b> The error code and the fault/ warning message will appear alternatively for every 5 seconds.</p>				
 0x1003	 5 seconds							
Battery disconnected								
6		Indicates that the buzzer is muted.						

### 3.3.2 Operation Mode Diagram Definition

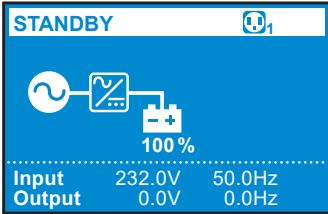
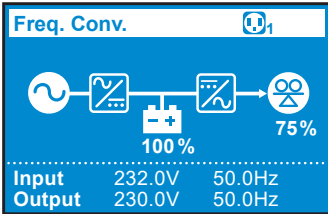
No.	Diagram	Description
1	 <p><b>ONLINE</b> </p> <p>100%</p> <p>75%</p> <hr/> <p><b>Input</b> 232.0V 50.0Hz <b>Output</b> 230.0V 50.0Hz</p>	Indicates <b>ONLINE</b> mode.
2	 <p><b>ECO</b> </p> <p>100%</p> <p>75%</p> <hr/> <p><b>Input</b> 232.0V 50.0Hz <b>Output</b> 232.0V 50.0Hz</p>	Indicates <b>ECO</b> mode.  <b>NOTE:</b> In ECO mode, the diagram's power flow will change according to the UPS input voltage and frequency. However, the <b>ECO</b> icon (  ) shown on the upper-left corner will not change even if the UPS transfers to online mode or battery mode.
3	 <p><b>BATTERY</b> </p> <p>Runtime <b>168</b> min</p> <p>100%</p> <p>75%</p> <hr/> <p><b>Input</b> 0.0V 0.0Hz <b>Output</b> 230.0V 50.0Hz</p>	Indicates <b>BATTERY</b> mode.
4	 <p><b>BYPASS</b> </p> <p>100%</p> <p>75%</p> <hr/> <p><b>Input</b> 232.0V 50.0Hz <b>Output</b> 232.0V 50.0Hz</p>	Indicates <b>BYPASS</b> mode.

No.	Diagram	Description
5	 <p>The diagram shows a blue rectangular display. At the top left, the word "STANDBY" is written in white. At the top right, there is a small icon of a battery with a plus sign. Below this, there is a power flow diagram: an AC sine wave icon on the left, followed by a transformer icon, then a battery icon with a plus sign, and a "100%" label below the battery. At the bottom, there is a table with two columns: "Input" and "Output". The "Input" row shows "232.0V" and "50.0Hz". The "Output" row shows "0.0V" and "0.0Hz".</p>	<p>Indicates <b>AC STANDBY</b> mode.</p>
6	 <p>The diagram shows a blue rectangular display. At the top left, the text "Freq. Conv." is written in white. At the top right, there is a small icon of a battery with a plus sign. Below this, there is a power flow diagram: an AC sine wave icon on the left, followed by a transformer icon, then a battery icon with a plus sign and "100%" below it, then another transformer icon, and finally an inverter icon with "75%" below it. At the bottom, there is a table with two columns: "Input" and "Output". The "Input" row shows "232.0V" and "50.0Hz". The "Output" row shows "230.0V" and "50.0Hz".</p>	<p>Indicates <b>Frequency Conversion</b> mode.</p> <p> <b>NOTE:</b>          In Frequency Conversion mode, the diagram's power flow will change according to the UPS input voltage and frequency. However, the text <b>Freq. Conv.</b> ( <b>Freq. Conv.</b> ) shown on the upper-left corner will not change even if the UPS transfers to battery mode.</p>

## Chapter 4 : Rear Panel

- **Models:**

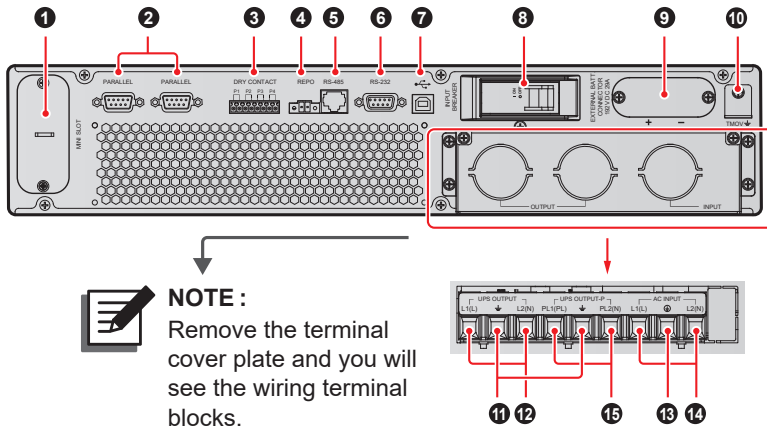

UPS502R2RT2N035 & UPS502R2RT2N0B0 & UPS502R2RT2N0B8 &  
 UPS602R2RT2N035 & UPS602R2RT2N0B0 & UPS602R2RT2N0B8 &  
 UPS802R2RT2N035 & UPS802R2RT2N0B0 & UPS802R2RT2N0B8 &  
 UPS103R2RT2N035 & UPS103R2RT2N0B0 & UPS103R2RT2N0B8

The rear panels of above mentioned models are similar. The differences are the battery voltage and DC value printed on the panels. For detailed information about the printed battery voltage and DC value, please refer to the table below. Here, only 5kVA UPS's rear panel (see **Figure 4-1**) is taken for example.



(Figure 4-1: 5kVA Rear Panel)

No.	Item	Functions
1	MINI Slot	For installation of an optional card, such as Mini SNMP IPv6 card, Mini Relay I/O card, or Mini MODBUS card. For more information, please refer to <b>Chapter 5: Communication Interfaces</b> .

No.	Item	Functions
②	Parallel Ports	<p>For UPS parallel communication. For more information, please refer to <b>Chapter 5: Communication Interfaces</b>.</p> <p> <b>NOTE :</b> To enhance parallel reliability, please adopt the Daisy Chain method to execute parallel configuration.</p>
③	Dry Contacts	<ol style="list-style-type: none"> <li>1. Output dry contacts: Receive the UPS's event information to indicate the UPS status or internal messages.</li> <li>2. Input dry contacts: Let the UPS to receive external control signals.</li> <li>3. For more information, please refer to <b>Chapter 5: Communication Interfaces</b>.</li> </ol>
④	REPO Port	<p>When emergency events occur, it can shut down the UPS safely and immediately. Please refer to <b>Chapter 5: Communication Interfaces</b> for details.</p>
⑤	RS-485 Port	<p>Connects to a computer so you can monitor the UPS status or let the UPS communicate with lithium ion batteries.</p>
⑥	RS-232 Port	<p>Connects to a computer so you can build up RS-232 communication, configure the UPS and upgrade the UPS firmware. Please refer to <b>Chapter 5: Communication Interfaces</b> for more information.</p>
⑦	 (USB Port)	<p>Connects to a computer to monitor the state of the UPS, configure the UPS parameters and update the management software. Please refer to <b>Chapter 5: Communication Interfaces</b> for more information.</p>

No.	Item	Functions
8	Input Breaker	Controls the UPS's input switch and for safety protection.
9	External Batt. Connector	Connects to the external battery pack (optional). 5K: 192V DC 29A 6K: 192V DC 35A 8K: 240V DC 37A 10K: 240V DC 46A
10	TMOV $\perp$	For UPS internal TMOV's grounding.
11	$\perp$	For loads' grounding.
12	UPS Output Terminal Block	<ol style="list-style-type: none"> <li>1. Uncontrollable.</li> <li>2. Without load-bank function.</li> <li>3. Connects to the loads (L1 &amp; L2 for suffix B8 model; L &amp; N for suffix 35/ B0 model).</li> </ol>
13	$\oplus$	For UPS grounding.
14	AC Input Terminal Block	Connects to the mains. (L1 & L2 for suffix B8 model; L & N for suffix 35/ B0 model)
15	UPS Output Terminal Block – P	<ol style="list-style-type: none"> <li>1. Controllable.</li> <li>2. With load-bank function.</li> <li>3. Connects to the loads (PL1 &amp; PL2 for suffix B8 model; PL &amp; N for suffix 35/ B0 model).</li> </ol> <p> <b>NOTE :</b></p> <ol style="list-style-type: none"> <li>1. Please note that, for parallel application, the output loads can only be connected to this output terminal block.</li> <li>2. When the UPS is working in single-unit mode, the output terminal block has load bank function. The load bank function will be disabled when the UPS is running in parallel mode.</li> </ol>

## Chapter 5 : Communication Interfaces



### NOTE :

1. The UPS can still function properly without making the connections below.
2. For the location of the following communication interfaces, please refer to *Figure 4-1~Figure 4-2*.

### 5.1 MINI Slot

The MINI slot is for mini-size cards. You can install the Mini SNMP IPv6, Mini Relay I/O, or Mini MODBUS card in this slot to let the system have network communication, dry contact function, and MODBUS communication respectively.

### 5.2 Parallel Ports

The two parallel ports are for UPS parallel communication. UPSs (at maximum 4) with the same capacity, voltage and frequency can be coupled via the provided parallel cable to run in parallel mode.

### 5.3 Dry Contacts

The RT UPS provides one input dry contact for you to receive external control signals. You can set up relevant items in the **Dry Contact Setting** screen, which includes Disable/ ROO/ RPO/ Remote shutdown/ Forced bypass/ On generator. Besides, there are three configurable output dry contacts for you to receive UPS events. The output dry contacts are normally open (NO). You can set up relevant items in the **Dry Contact Setting** screen, which includes Disable/ On bat/ Low bat/ Bat fault/ Bypass/ UPS OK/ Load protected/ Load powered/ General alarm/ Overload alarm. Please refer to **9.2.2 Setting Menu** and **9.2.4 Maintenance Menu** for relevant information.

### 5.4 REPO Port

The REPO port can be connected to an external switch. After the external switch is turned to the '**CLOSED**' position, the UPS will switch off the inverter immediately and cut off the UPS output without transferring to bypass mode.

**NOTE :**

1. You can use the management software to configure the REPO port as normally open (NO) or normally closed (NC). The factory default setting is normally open (NO).
2. The REPO port can also be used for ROO application, which allows you remotely turn on/ off the inverter. If you need detailed ROO information or ROO setup service, please contact your local dealer or customer service. Please note that this port can only be modified by qualified service personnel.

## 5.5 RS-232 Port

You can use a RS-232 cable (user supplied) to connect the UPS with a computer and install the UPSentry 2012 software\*<sup>1</sup> to check and monitor the UPS status.

- **The RS-232 port provides the following functions**

1. RS-232 communication (baud rate: 2400/ 9600)
2. UPS configuration
3. Firmware upgrade (baud rate: 9600)

- **Pin Assignment**

1. PIN 2: TXD <Transmitting Data>
2. PIN 3: RXD <Receiving Data>
3. PIN 5: GND <Signal Ground>

- **Hardware**

1. Baud Rate: 2400/ 9600bps
2. Data Length: 8 bit
3. Stop Bit: 1 bit
4. Parity: None

**NOTE :**

1. \*<sup>1</sup> You can download the software from the following link:  
<http://www.deltapowersolutions.com/en/mcis/ups-software.php>.
2. Do not use the USB port and the RS-232 port simultaneously. If you connect the USB cable (user-supplied) to the USB port, the RS-232 port will be disabled right away.



## 5.6 USB Port

Please use the provided USB cable to connect the UPS with a computer and install the UPSentry 2012 software\*<sup>1</sup> to check and monitor the UPS status. The USB port has the following functions:

1. HID USB communication
2. UPS configuration with EEPROM programming
3. UPS firmware upgrade
4. Event logs download
5. Dry contacts setup



### NOTE :

1. \*<sup>1</sup> You can download the software from the following link:  
<http://www.deltapowersolutions.com/en/mcis/ups-software.php>.
2. Do not use the USB port and the RS-232 port simultaneously. If you connect the USB cable (user-supplied) to the USB port, the RS-232 port will be disabled right away.

## 5.7 RS-485 Port

You can use the RS-485 port to check and monitor the UPS status.

- **The RS-485 port provides the following functions**

1. Lithium-ion battery communication
2. RS-485 communication (baud rate: 9600)\*<sup>1</sup>

- **Pin Assignment**

1. PIN 7: RS485 D+
2. PIN 8: RS485 D-

- **Hardware**

1. Baud Rate: 9600bps
2. Data Length: 8 bit
3. Stop Bit: 1 bit
4. Parity: None

**NOTE :**

\*1: The RS-485 port is mainly designed for lithium-ion battery communication. If you don't use the lithium-ion batteries and would like to check and monitor the UPS via the MODBUS protocol, the RS-485 port (PIN 7 & PIN 8) is supportive.

## 5.8 External Battery Connector

To increase the battery backup time, you can connect several external battery packs to the UPS. The connector is for connection to the external battery pack(s). Please see below for relevant information.

- **Battery**

UPS	Charge Voltage	Charge Current	Low Battery Shutdown	The Number Of Batteries
5kVA/ 6kVA	219.2Vdc	1A (default)* <sup>1</sup>	168V±3%	12V × 16 PCS
8kVA/ 10kVA	274Vdc	1.5A (default)* <sup>1</sup>	210V±3%	12V × 20 PCS

**NOTE :**

\*1: For suffix B0 model, its charge current default setting is 4A.

**WARNING:**

1. Please refer to the table below to select the charge current for 5kVA/ 6kVA/ 8kVA/ 10kVA UPS.
2. If you need to modify the charge current default setting, please contact your local dealer or customer service.

5kVA/ 6kVA UPS	Level 1	Level 2	Level 3	Level 4
<b>Total Battery Capacity</b>	5~9Ah	9~17Ah	18~30Ah	27~40Ah
<b>Charge Current</b>	1A	2A	3A	4A

8kVA/ 10kVA UPS	Level 1	Level 2	Level 3	Level 4
<b>Total Battery Capacity</b>	9~17Ah	17~20Ah	20~30Ah	27~40Ah
<b>Charge Current</b>	1.5A	2A	3A	4A

• **External Battery Pack**

1. Delta external battery pack is optional. Please refer to the Quick Guide, User Manual or Installation & Operation Guide included in the package of the external battery pack.
2. When connecting the external battery pack with the UPS, you must install an appropriate non-fuse DC breaker or the fast-acting fuse that meets the safety certification. Do not use an AC breaker.
3. The breaker must be a 2-pole non-fuse DC breaker with characteristics of 1-pole 250Vdc, 2-pole 500Vdc and 35kA (or above) DC breaking capacity.

• **Battery/ Battery Pack Connection Warnings**

1. Only use the same type of batteries from the same supplier. Never use old, new and different Ah batteries at the same time.
2. The number of batteries must meet UPS requirements.
3. Do not connect the batteries in reverse.
4. Use the voltage meter to measure whether the total voltage, after battery pack connection, is around  $12.5Vdc \times$  the total number of batteries.



**NOTE:**

1. Turn off the UPS and cut off the AC source before performing battery/ battery pack replacement.
2. A battery can present a risk of electric shock and high short-circuit current.
3. Servicing of batteries and battery packs must be performed or supervised by qualified service personnel knowledgeable in batteries, battery packs and the required precautions. Keep unauthorized personnel away from batteries and battery packs.

- **Alarm**



When any external battery pack connected to the UPS has the following problems, the UPS system will sound an alarm. Please see the table below.

No.	External Battery Pack Status	Description
1	Battery Mode	The alarm beeps once every 2 seconds.
2	Battery Low Warning	The alarm beeps once every 0.5 second.
3	Battery Missing/ Weak Battery/ Battery Replacement	The alarm beeps once every 2 seconds.
4	Overload	1. Overload_105%~125%: The alarm beeps once every 2 seconds. 2. Overload_125%~150%: The alarm beeps once every 0.5 second.
5	Fault	The alarm beeps continuously for 5 seconds when the UPS detects an internal fault. After the 5-seconds long beep, the alarm beeps once every 2 seconds.



**NOTE :**

\*1: After reconnecting or replacing the batteries, it might take a while for the UPS to switch off the alarm automatically. If, after a period of time, the audible alarm still exists, please manually initiate a battery test. Please follow the route below to execute the manual battery test in order to clear the alarm.

**Route:** press the button  for 0.1 second → select  → select **Test** → select **Start Battery Test**. For relevant information, please refer to **9.2 Main Menu**.

## Chapter 6 : Installation

Please refer to the system block diagram and related information below for correct installation.

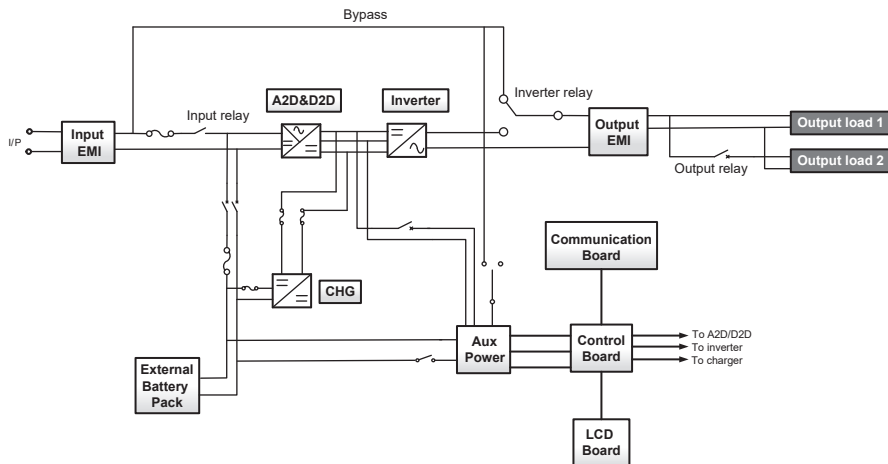

### 6.1 Rack Mounting

Use the included bracket ears and screws to mount the UPS in a rack by following the procedures below.

- 1 Attach the included bracket ears to the lateral mounting holes of the UPS. See **Figure 6-1**.

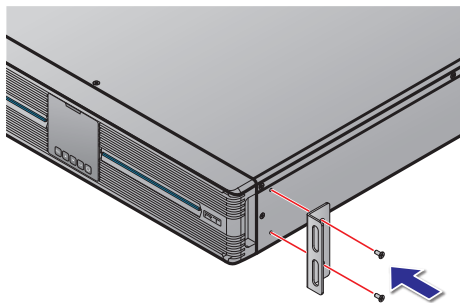

(Figure 6-1: UPS Bracket Ear Installation)

2 Follow steps 1 to 4 to install the UPS in Delta's rail kit (optional). See **Figure 6-2**.

Step 1 : Adjust the length of the rail according to the rack.

Step 2 : Tighten the nuts.

Step 3 : Fix the rail on the rack.

Step 4 : Insert the UPS in the rack and tighten the screws.

3 If you want to use a non-Delta rail kit, please only follow step 4 .

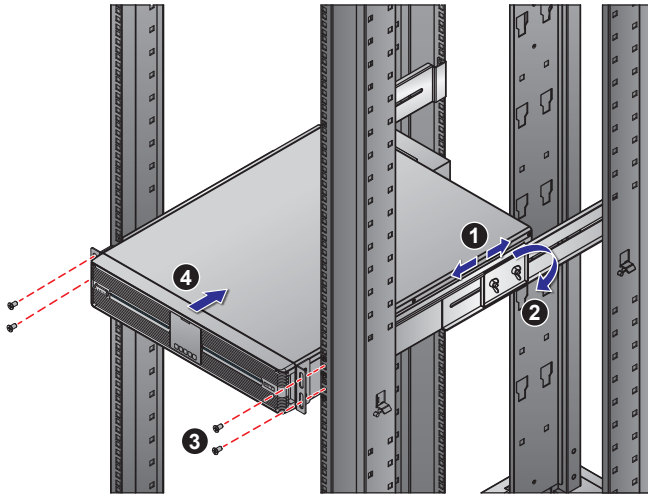

(Figure 6-2: Rack Mounting)



**NOTE:** If you need the optional rail kit, please contact your local dealer.

## 6.2 Tower Mounting

Use the included tower stands to mount the UPS in an upright tower position by following the steps below.

- 1 Assemble the tower stands (see **Figure 6-3**).

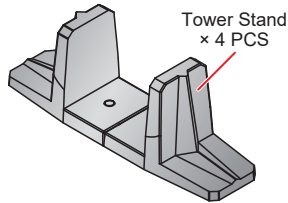

(Figure 6-3: Assemble the Tower Stands for 5/ 6/ 8/ 10kVA UPS)

- 2 Pull out the control panel 1, rotate the panel and the Delta logo nameplate 90° clockwise 2 and re-insert the control panel 3 (see **Figure 6-4**).

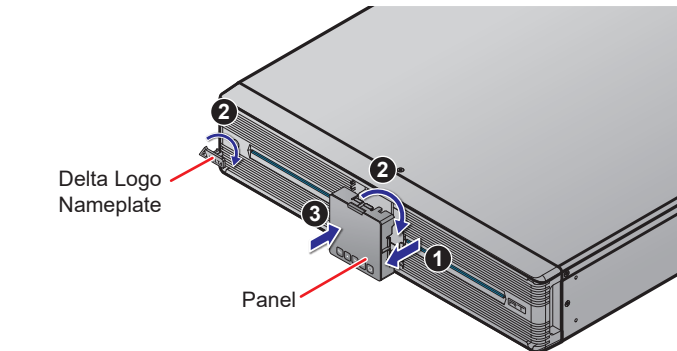

(Figure 6-4: Rotate the Control Panel and the Delta Logo Nameplate)

- 3 Carefully lift the whole unit upright 4 with the Delta logo nameplates and the icons shown on the panels facing up.

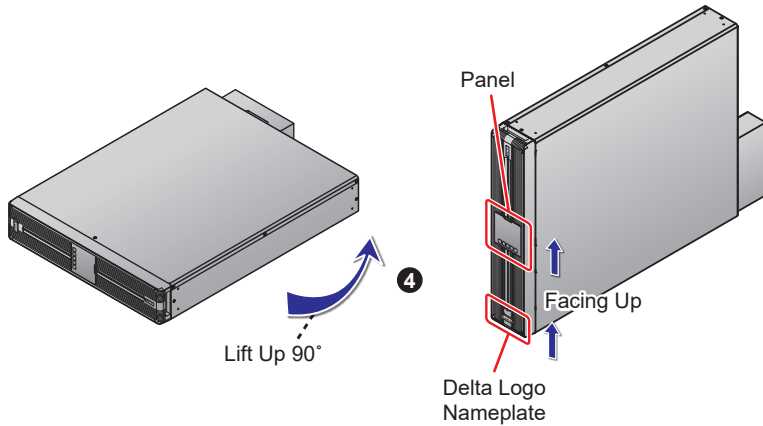

(Figure 6-5: Place the Whole Unit Upright)

4 Place the whole unit inside the tower stands 5.

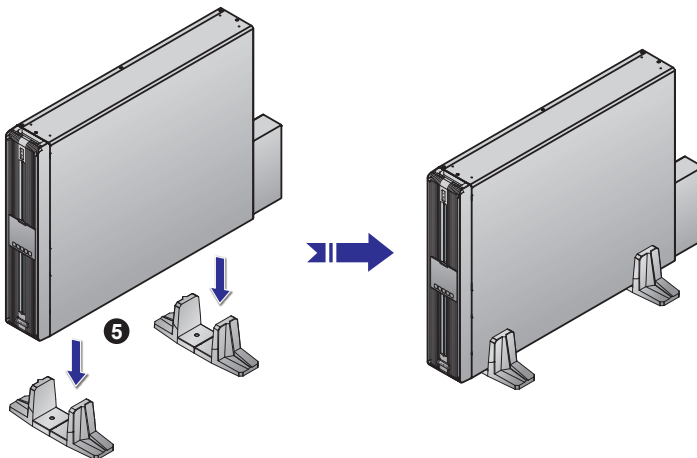

(Figure 6-6: Place the Whole Unit inside the Tower Stands)

Leave adequate space (at least 50cm) around all sides of the unit for good ventilation.



**NOTE:** A minimum of two people are required to execute 3 and 4.



# Chapter 7 : Connection and Wiring

## 7.1 UPS Connection Warnings

- 1) When connecting the UPS to the mains and the loads, it is highly recommended that you install the protective devices. Please refer to the table below and *Figure 7-3*.

UPS Power Rating	Suggested Protective Device	Suggested Supplier
5/ 6kVA	D curve-50A circuit breaker	DELIXI
8/ 10kVA	D curve-80A circuit breaker	DELIXI

- 2) The protective devices must use approved components that meet safety certifications.
- 3) The power supplying to the UPS must be single-phase in accordance with the unit's rating label, and the UPS must be properly grounded.

## 7.2 Input/ Output Connection

- 1) Please see the figures below for input/ output connection.

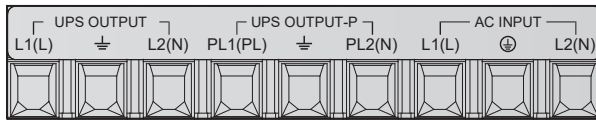

(Figure 7-1: Input/ Output Wiring Terminal Block)

- 2) **Cable Selection:**

For the specifications of input/ output cables, please refer to **Table 7-1**.

**Table 7-1: Specifications of Input/ Output Cables**

<b>Spec. / Capacity</b>	<b>5/ 6kVA (Suffix: B8)</b>	<b>8/ 10 kVA (Suffix: B8)</b>
Input/ Output Cables (Rating Temperature 90°C)	#8AWG	#6AWG
Tightening Torque (For AC Wiring)	25.5kgf·cm	25.5kgf·cm
<b>Spec. / Capacity</b>	<b>5/ 6kVA (Suffix: 35)</b>	<b>8/ 10 kVA (Suffix: 35)</b>
Input/ Output Cables	6mm <sup>2</sup>	10mm <sup>2</sup>
Tightening Torque (For AC Wiring)	25.5kgf·cm	25.5kgf·cm

In accordance with **National Electrical Codes (NEC)**, please install the suitable conduits and cable sleeves.

- 3) When connecting the input/ output power cords, please observe the following rules.
1. Turn off the UPS and cut off both AC source and the battery source before connection.
  2. Calculate the power consumption of the loads to avoid an overload condition.
  3. Ensure that the screws are tightly fixed after connection. Please refer to **Table 7-1**.

4) **Backfeed Protection:**

When the UPS runs in battery mode or during AC power failure, the UPS's inner voltage or energy might be fed back to the input terminals, either directly or via a leakage loop. To avoid the risk of electric shock resulted from the backfeed, installation of a backfeed protection device between the AC input and the UPS is highly recommended.



**NOTE :**

1. The UPS doesn't have any built-in backfeed protection device. Installation of the backfeed protection device between the AC input and the UPS is highly recommended.
2. If there is no backfeed protection device installed between the AC input and the UPS, please (1) attach a warning label on the switch or breaker that controls the AC power supplying to the UPS, and (2) check if any hazardous voltage exists on any terminals connected to the AC power. The warning label shall carry the following wording or equivalent.

**Before Working on This Circuit**  
 -Isolate Uninterruptible Power System (UPS)  
 -Then check for Hazardous Voltage between all terminals including the protective earth.



**Risk of Voltage Backfeed**

• **Backfeed Protection Device Requirements:**

UPS	Suggested Backfeed Protection Device Rating Voltage/ Current	Suggested Model No.
5/ 6kVA	208/ 220/ 230/ 240Vac; 40A	AF52-30-13 (ABB)
8/ 10kVA	208/ 220/ 230/ 240Vac; 65A	AF52-30-13 (ABB)

• **Control Relay Requirements:**

<b>Breaking Capacity</b>	240Vac/ 5A
<b>Contact Form</b>	Normally Closed (NC)
<b>Coil</b>	12Vdc/ <0.5A
<b>Suggested Model No.</b>	HF13F-012-1Z1T

• **Backfeed Protection Wiring Diagram:**

Please refer to the diagram below to install the backfeed protection device between the AC input and the UPS.

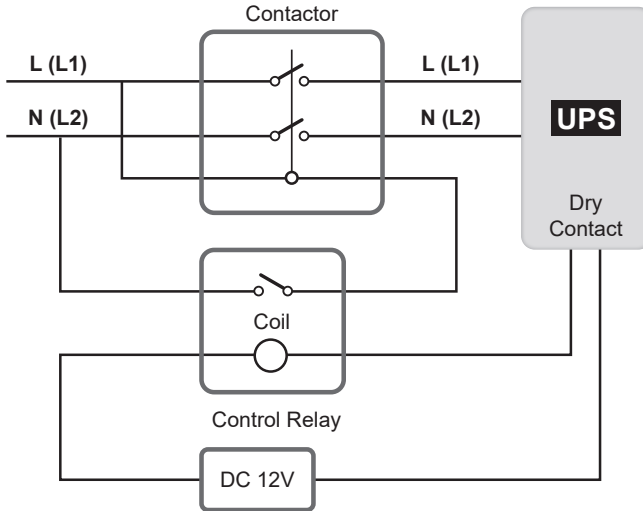

(Figure 7-2: Backfeed Protection Wiring Diagram)

### 7.3 Single Unit Wiring

- 1) Remove the terminal cover plate and you will see the wiring terminal block shown in **Figure 7-1**.
- 2) Confirm the input breaker is in the **OFF** position.
- 3) According to the capacity and the model of your UPS, select proper input and output cables.
- 4) Connect the main AC source/ output/ external battery pack cables to the wiring terminal block. Please refer to **Figure 7-3**.
- 5) Ground the UPS.

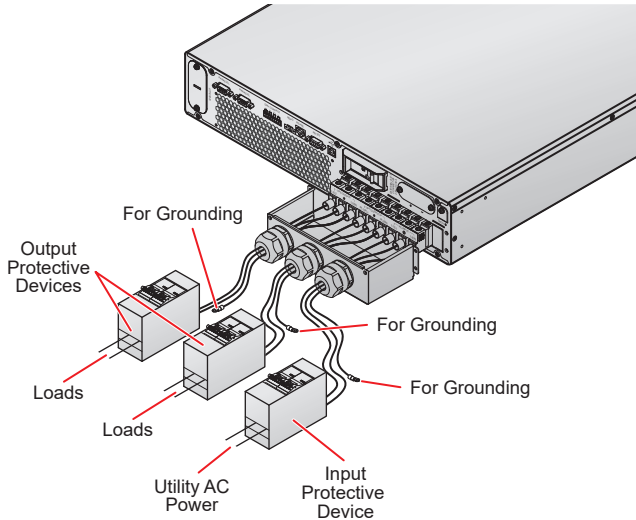

(Figure 7-3: Single Unit Wiring Diagram)

## 7.4 Parallel Units Wiring



### NOTE:

1. You can parallel at maximum four UPS units. To enhance parallel reliability, please adopt the Daisy Chain method to execute parallel configuration. Please refer to **Figure 7-4**.
2. Please ensure that each parallel UPS's wiring is correct, and all external output protective devices are in the 'OFF' position. For the location of output protective devices, please refer to **Figure 7-3**.
3. When UPSs are paralleled, the diameter and the length of each parallel UPS's input cables and output cables must be equal. This ensures that the parallel UPSs can equally share the equipment loads in bypass mode.
4. Before start-up of the parallel system, make sure that each UPS's ID is correctly set up and each unit's major parameters are set the same. For the major parameters' information, please contact service personnel.
5. Ensure that each parallel UPS is completely turned on before starting up the loads. To prevent the UPS from activating the overload protection mechanism during start-up process, please turn on the high-power loads first and then low-power loads.
6. The parallel UPSs cannot connect with common batteries.
7. The parallel UPSs cannot run in ECO mode.

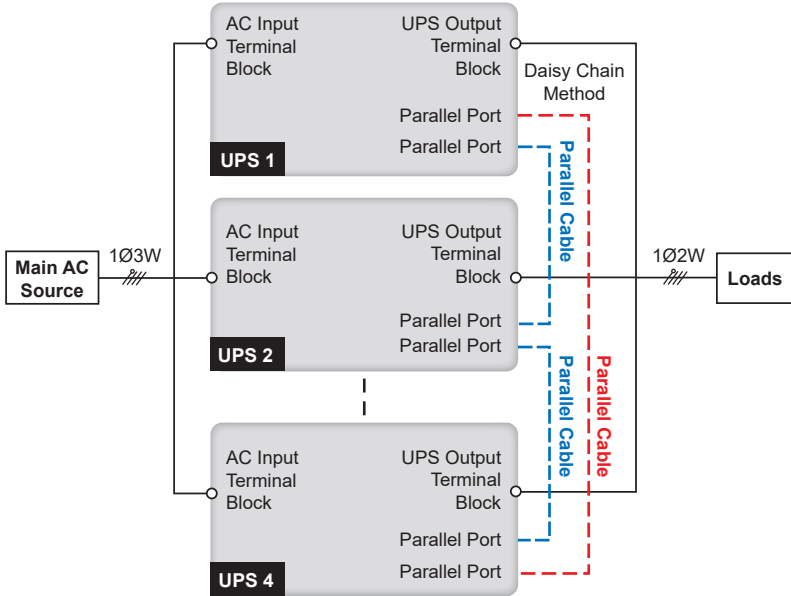

(Figure 7-4: Parallel Units Wiring Diagram)

- 1 Please follow steps 1 ~ 4 stated in 7.3 **Single Unit Wiring**.
- 2 Use the provided parallel cable to connect the parallel ports on the parallel units.
- 3 Ground the parallel UPSs.

## 7.5 External Battery Pack Connection

To increase the battery backup time, you can connect several external battery packs to the UPS. Please follow the steps below (**Figure 7-5 & Figure 7-6**) and information in **5.7 External Battery Connector** to complete the connection.



### NOTE:

1. When connecting the external battery pack with the UPS, you must install an appropriate non-fuse DC breaker or the fast-acting fuse that meets the safety certification. Do not use an AC breaker.
2. The breaker must be a 2-pole non-fuse DC breaker with characteristics of 1-pole 250Vdc, 2-pole 500Vdc and 35kA (or above) DC breaking capacity.

- 1 Remove the two screws from the external battery connector's panel shown below.

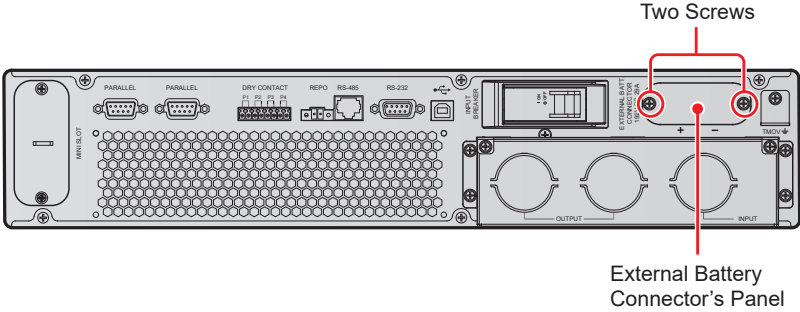

(Figure 7-5: Remove External Battery Connector's Panel)

- 2 Insert the provided battery cable into the external battery connector 1 and use the provided two screws and two standoffs to firmly fix the battery cable 2.

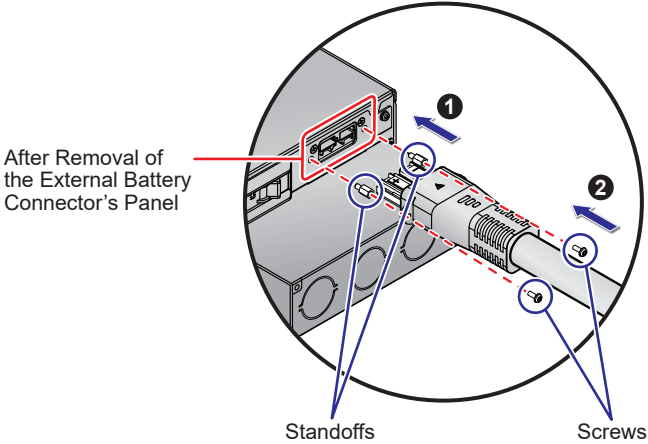

(Figure 7-6: Battery Cable Connection)

# Chapter 8 : Operation

## 8.1 Single Unit Start-up



### NOTE :

1. Before start-up, ensure that the batteries are fully charged. Before using the UPS for the first time, please check the battery capacity and the charging settings. Make sure that you charge the batteries until the battery capacity percentage shown on the UPS's LCD is 100% ().
2. The configurable battery Q'ty is 12, or 16 ~ 22. Please make sure that the actual battery Q'ty is the same as that is configured on the LCD. Set up the corresponding charge current based on the total battery amp-hour.
3. If the UPS connects to an inductive load, the inrush current (initial surge current) may restart the inverter. To avoid this situation, please turn on the inductive load in bypass mode before starting up the inverter.

### 8.1.1 Start-up with AC Input (Single Unit)

- ① Verify if the UPS's input cord meets with N, L & G of the wall socket and the utility AC power works normally.
- ② Switch on the input protective device (see **Figure 7-3**) installed between the UPS and the utility AC power and switch on the input breaker. After that, the UPS will enter the **Initial Setting Screen** (please refer to **9.1 Initial Setting Screen** for more information).
- ③ Press and hold the **ON/ OFF** button () for 3 seconds to start up the UPS. Release the button after you hear one beep and the UPS will start up. After the UPS performs self-diagnosis, the UPS will run in **ON-LINE** mode.



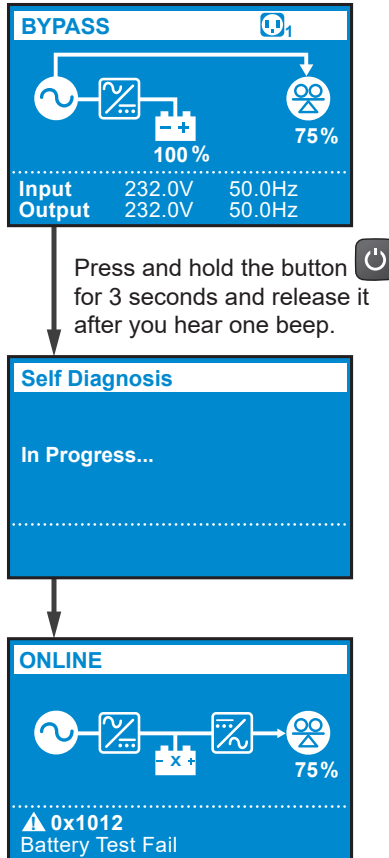

- ④ Once the UPS runs normally, switch on the output protective devices (see *Figure 7-3*) installed between the UPS and the loads.

### 8.1.2 Start-up with Batteries (Single Unit)

- ① Please check the '+' and '-' poles of the batteries and ensure that wiring is correct.
- ② Turn on the UPS's external battery pack's breaker.
- ③ When there is no AC input, press and hold the **ON/ OFF** button () for 3 seconds to start up the UPS. Release the button after you hear one beep and the UPS will start up. After the UPS performs self-diagnosis, the UPS will run in **BATTERY** mode.

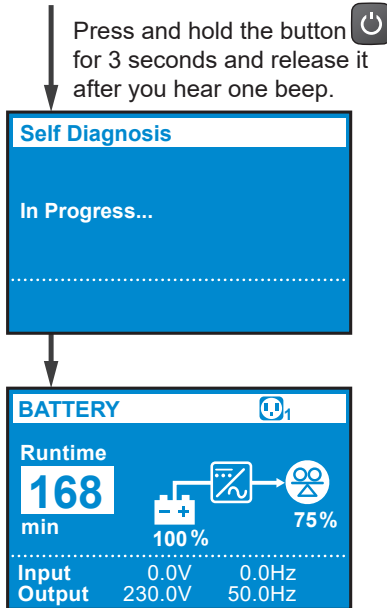





- ④ Once the UPS runs normally, switch on the output protective device (see **Figure 7-3**) installed between the UPS and the loads.



**NOTE:**

To prevent the UPS from activating the overload protection mechanism during start-up process, please turn on the high-power loads first and then low-power loads.

## 8.2 Single Unit Turn-off

- ① Make sure all of the loads connected to the UPS are off.
- ② (1) Press and hold the **ON/ OFF** button (  ) for 3 seconds, (2) release it after you hear one beep, (3) use the Scrolling UP or Down button (  /  ) to select 'Yes', and (4) press the Enter button (  ) to confirm your selection.

- 3 Switch off the input breaker, input protective device (see **Figure 7-3**) and output protective devices (see **Figure 7-3**).
- 4 After the LCD backlight goes dim and the fans stop completely, switch off the battery breaker to ensure that there is no remaining battery power.

## 8.3 Parallel Units Start-up



### NOTE:

1. You can parallel at maximum four UPS units. To enhance parallel reliability, please adopt the Daisy Chain method to execute parallel configuration. Please refer to **Figure 7-4**.
2. Please ensure that each parallel UPS's wiring is correct, and all external output protective devices are in the 'OFF' position. For the location of output protective devices, please refer to **Figure 7-3**.
3. When UPSs are paralleled, the diameter and the length of each parallel UPS's input cables and output cables must be equal. This ensures that the parallel UPSs can equally share the equipment loads in bypass mode.
4. Before start-up of the parallel system, make sure that each UPS's ID is correctly set up and each unit's major parameters are set the same. For the major parameters' information, please contact service personnel.
5. Ensure that each parallel UPS is completely turned on before starting up the loads. To prevent the UPS from activating the overload protection mechanism during start-up process, please turn on the high-power loads first and then low-power loads.
6. The parallel UPSs cannot connect with common batteries.
7. The parallel UPSs cannot run in ECO mode.

### 8.3.1 Start-up with AC Input (Parallel Units)

- 1 Ensure that input and output connection is correct for the parallel system.
- 2 Turn on each UPS's external battery pack's breaker.
- 3 Turn on each UPS's input protective device and input breaker. For the location of input protective device, please refer to **Figure 7-3**.
- 4 Press and hold each parallel UPS's **ON/ OFF** button () for 3 seconds to start up the UPS. Release the button after you hear one beep and the UPS will start up. After each UPS performs self-diagnosis, each parallel UPS will run in **ON-**

**LINE** mode.

- 5 Turn on each UPS's output protective devices. For the location of output protective devices, please refer to **Figure 7-3**.
- 6 Once the parallel system runs normally, please turn on the high-power loads first and then low-power loads.

### 8.3.2 Start-up with Batteries (Parallel Units)

- 1 Please check the '+' and '-' poles of the batteries and ensure that wiring is correct.
- 2 Turn on each UPS's external battery pack's breaker.
- 3 Press and hold each parallel UPS's **ON/ OFF** button (🔌) for 3 seconds to start up the UPS. Release the button after you hear one beep and the UPS will start up. After each UPS performs self-diagnosis, each parallel UPS will run in **Battery** mode.
- 4 Turn on each UPS's output protective devices. For the output protective devices' location, please refer to **Figure 7-3**.
- 5 Once the parallel system runs normally, please turn on the high-power loads first and then low-power loads.

### 8.4 Parallel Units Turn-off

- 1 Make sure all of the loads connected to each Parallel UPS are off.
- 2 (1) Press and hold each parallel UPS's **ON/ OFF** button (🔌) for 3 seconds, (2) release it after you hear one beep, (3) use the Scrolling UP or Down button (⬆️/⬇️) to select '**Yes**', and (4) press the Enter button (👉) to confirm your selection. After that, the parallel system will transfer to bypass mode if bypass power runs normally.
- 3 Turn off each UPS's input breaker, input protective device and output protective devices. For the input and output protective devices' location, please refer to **Figure 7-3**. After the LCD backlight goes dim and the fans stop completely, the parallel system will completely shut down.
- 4 Switch off each UPS's external battery breaker or disconnect all external battery cables from the parallel UPSs to ensure that there is no remaining

battery power.

## 8.5 Operation Mode

- **Standby Mode**

After the UPS is connected to the utility AC power, it will supply power to the UPS and the batteries will be charged.

- **Online Mode**

In on-line mode, the connected loads are supplied by the inverter, which derives its power from the utility AC power, and the UPS charges the batteries and provides power protection to its connected loads.

- **Bypass Mode**

In bypass mode, the critical loads are directly supplied by the utility AC power and the batteries are charged. The default setting of the UPS is set in **BYPASS** mode.

- **Battery Mode**

When the UPS is operating during a power outage, the batteries provide DC power, which maintains inverter operation to supply power to the critical loads.

You can install the UPSentry 2012 software (please download from <http://www.deltapowersolutions.com/en/mcis/software-center.php>) or install the Mini SNMP IPv6 card (optional) or the Mini MODBUS card (optional) to monitor and estimate the battery remaining capacity. For more information about the Mini SNMP IPv6 card (optional) or the Mini MODBUS card (optional), please refer to its user manual.

- **ECO Mode**

In ECO mode, when the utility input voltage and frequency are within the range of rating voltage  $\pm 10\%$  and rating frequency  $\pm 3\text{Hz}$ , the loads are supplied by the utility AC power; if out of the range, the loads are supplied by the inverter.

- **Frequency Conversion Mode**

In Frequency Conversion mode, the UPS output frequency is manually set up. The system will disable the bypass function and there is no bypass output.

## Chapter 9 : LCD Display & Settings



### NOTE:

1. Please refer to **Chapter 3: Operation Panel** to learn how to use the operation panel and understand every icon/ diagram definition.
2. Each of the display diagrams shown in this chapter is for reference only. Actual display depends on the operation of the UPS.

### 9.1 Initial Setting Screen

When the UPS is powered on for the first time, the LCD display will show the **Initial Setting Screen** and you can modify language, output voltage, battery parameters based on actual needs during initial setup. The default settings of language, output voltage, and battery parameters may vary according to different models. Press the  button to continue if there is no special requirement. After you configure the **Language, Date & Time, Output Setting, External Battery Type** and **External Battery Capacity** settings, the LCD display will move to the **Main Screen** that shows the current operation mode.

The following flow chart helps you to navigate the LCD screen.

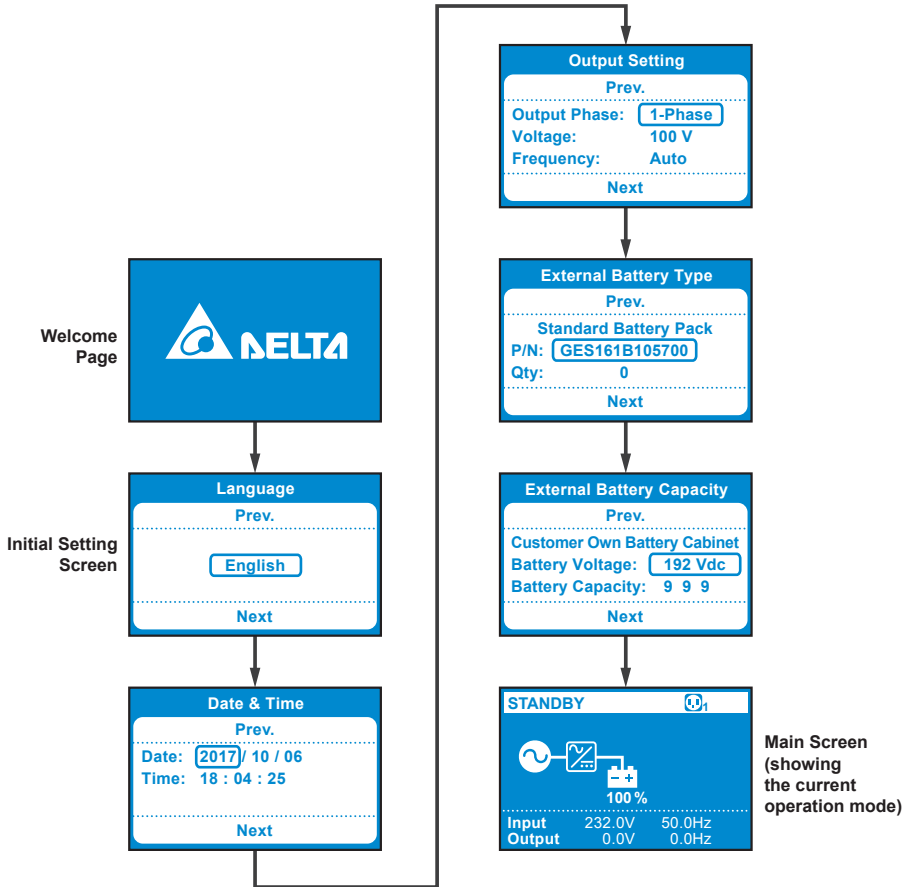

The **Initial Setting Screen** will no longer appear after initial configuration. Next time, when the UPS is powered on, the LCD display will show **DELTA** welcome page for 3 seconds and then directly go to the **Main Screen** that shows the current operation mode.

Welcome Page

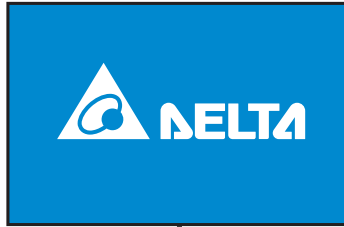

Main Screen

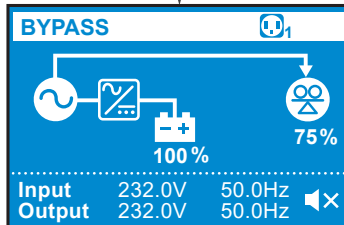

## 9.2 Main Menu

In the **Main Screen**, press the button  for 0.1 second to enter the **Main Menu**. You can set up relevant items here.

Main Menu













### NOTE:

Please note that only qualified service personnel can perform setup actions.



For setup procedures, please refer to the following:

- 1 In the **Main Menu**, select the item you want to configure, press the **ENTER** button  for 0.1 second and the UPS will enter the setup mode.
- 2 Press the button  for 0.1 second or press the button  for 0.1 second to navigate the setting items.
- 3 Press the button  for 0.1 second to choose the parameter that you want to change, and the parameter will flash.
- 4 Press the button  for 0.1 second or press the button  for 0.1 second to increase or decrease the parameter value. If either of the buttons is pressed for over 2 seconds, the LCD will automatically switch between the selectable values every 0.2 second until either of the buttons is released or the number reaches its highest or lowest value.
- 5 Press the button  to confirm your parameter setup or press the button  to go back to the previous status.
- 6 After that, press the button  for 0.1 second or press the button  for 0.1 second to move to the previous or the next setting item.
- 7 In setup mode, press the  button and the LCD will exit from the setup mode.
- 8 In setup mode, if you don't press any button for more than 5 minutes, the LCD will exit from the setup mode and go back to the original display automatically.

Please refer to the **Menu Tree** below for all setting options.

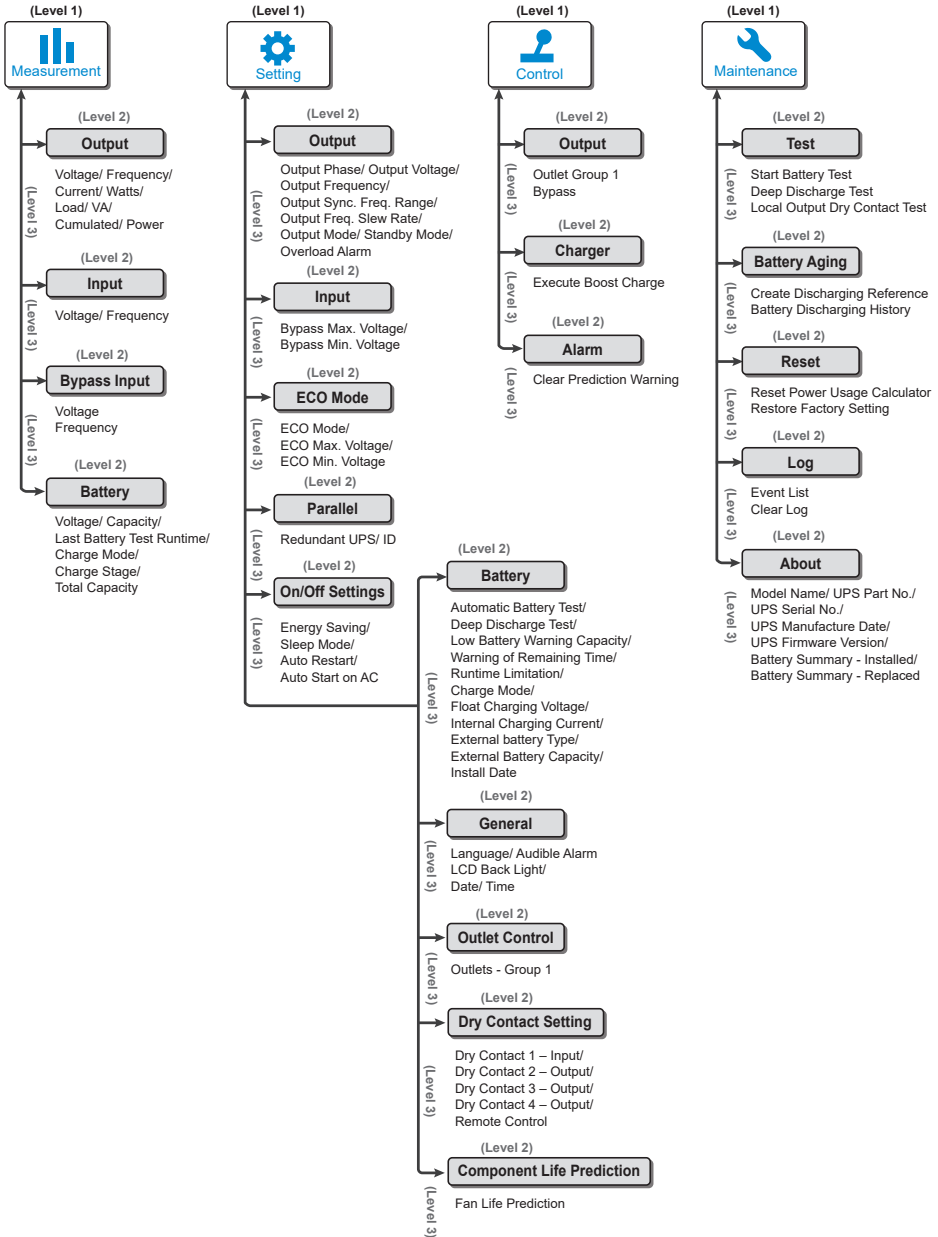



(Figure 9-1: Menu Tree)

## 9.2.1 Measurement Menu

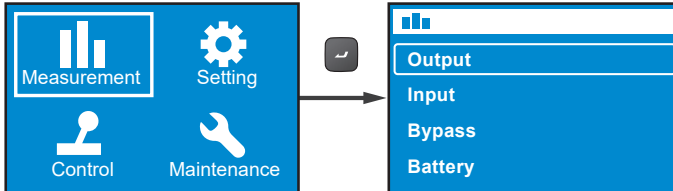
In **Main Menu**, after selecting  , press the button  to enter the **Measurement Menu**. The **Measurement Menu** displays the UPS's status readings, such as **Output**, **Input**, **Bypass** and **Battery** information.



## 9.2.2 Setting Menu

In **Main Menu**, after selecting  , press the button  to enter the **Setting Menu**.

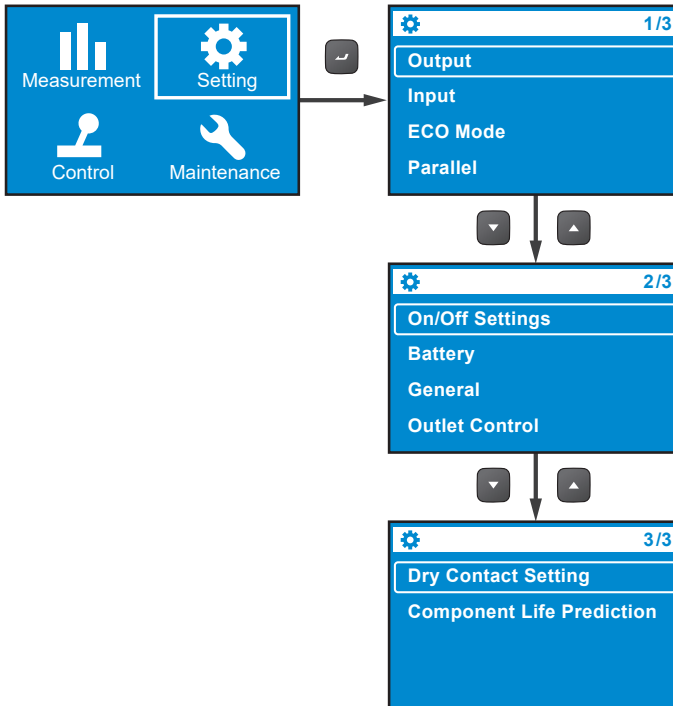

You can choose the setup items such as **Output, Input, ECO Mode, Parallel, On/ Off Settings, Battery, General, Outlet Control, Dry Contact Setting** and **Component Life Prediction** to set up relevant settings. For more information about the **Setting Menu**, please refer to the tables below for each setup item's relevant default value and selectable value.

- **Output**

Setup Items	Selectable Value	Default
<b>Output Phase</b>	1-phase	1-phase
<b>Output Voltage</b>	200V, 208V, 220V, 230V, 240V	208V for suffix B8 model 230V for suffix 35 & B0 models
<b>Output Frequency</b>	Auto* <sup>1</sup> / Converter-50Hz* <sup>2</sup> / Converter-60Hz* <sup>2</sup>	Auto
<b>Output Sync. Freq. Range</b>	±0.5/ 1/ 3/ 5Hz	±3Hz
<b>Output Freq. Slew Rate</b>	0.5/ 1/ 2/ 3/ 4 Hz/ sec.	1 Hz/sec.
<b>Output Mode</b>	Industrial/ IT	IT
<b>Standby Mode</b>	No output/ Bypass output	Bypass output
<b>Overload Alarm</b>	30-105% (per step: 5%)	105%



**NOTE :**

- \*<sup>1</sup>: When the **Output Frequency** is set as **Auto**, the output frequency will vary according to the bypass frequency. If the bypass frequency is  $\geq 55\text{Hz}$ , the **Free\_Run\_Frequency/ Cold\_Start\_Frequency** will be set as 60Hz.  
If the bypass frequency is  $< 55\text{Hz}$ , the **Free\_Run\_Frequency/ Cold\_Start\_Frequency** will be set as 50Hz.
- When the **Output Frequency** is set as **Auto** and the **Bypass Output** under the **Standby Mode** item is set as **Enable**, the bypass output range will be the same as the **Output Sync. Freq. Range**.
- \*<sup>2</sup>: When the **Output Frequency** is set as **Converter-50Hz/ Converter-60Hz**, the UPS will enter the **Frequency Conversion** mode and the bypass output will become **Disable**.

• Input

Setup Item	Selectable Value	Default Value
Bypass Max. Voltage	+10/ 15/ 20%	+15%
Bypass Min. Voltage	-10/ 15/ 20/ 25/ 30/ 35/ 40%	-20%

• ECO Mode

Setup Item	Selectable Value	Default Value
ECO Mode	Disable/ Enable	Disable
ECO Max. Voltage	5-15% (per step: 1%)	+10%
ECO Min. Voltage	5-15% (per step: 1%)	-10%



**NOTE :**

The setup items **ECO Max. Voltage** and **ECO Min. Voltage** will only be shown on the display when ECO Mode is enabled.

• Parallel



**NOTE :**

The following function is not applicable to the Standard Runtime Model.

Setup Item	Selectable Value	Default Value
Redundant UPS	0-3 (per step: 1)	0
ID	1-4 (per step: 1)	1

• On/ Off Settings

Setup Item	Selectable Value	Default Value
Energy Saving	Option 1*: Enable/ Disable Option 2: 1-15mins (per step: 1min) Option 3: 300W-1500W (per step: 100W)	Disable
Sleep Mode	Option 1: Enable/ Disable Option 2: 10-120mins (per step: 10mins)	Disable

Setup Item	Selectable Value	Default Value
Auto Restart	Enable/ Disable	Enable
Auto Start on AC	Enable/ Disable	Disable



**NOTE :**

In **Setting Menu**, the sub item **Option 1** under the item **Energy Saving** cannot be changed.

- **Battery**

Setup Item	Selectable Value	Default Value
Automatic Battery Test	No test/ Daily/ Weekly/ Biweekly/ Monthly	No test
Deep Discharge Test	20-90% (per step: 10%)	90%
Low Battery Warning Capacity	0-95% (per step: 5%)	10%
Warning of Remaining Time	0-60mins (per step: 1min)	2mins
Runtime Limitation	Disable/ 1/ 2/ 3..../ 240mins (per step: 1min)	Disable
Charge Mode	2-stage/ 3-stage	2-stage
Float Charging Voltage	Auto/ Customize (2.20 - 2.35 V/ cell, per step: 0.01V)	Auto
Internal Charging Current	For 5K/ 6K: 1/ 2/ 3/ 4/ 5/ 6/ 7/ 8A* <sup>1</sup> For 8K/ 10K: 1.5/ 2/ 3/ 4/ 5/ 6A	1A (5K/ 6K)* <sup>2</sup> 1.5A (8K/ 10K)* <sup>2</sup>
External Battery Type* <sup>3</sup>	Standard battery pack/ Customer own batt. pack	

Setup Item	Selectable Value	Default Value
<b>External Battery Capacity</b>	Standard battery pack: Part Number Quantity  Customer own batt. pack: Battery Voltage Capacity	
<b>Install date</b>	YYYY/ MM/ DD	



**NOTE :**

\*1: Under the condition of rated battery voltage  $\leq 192\text{Vdc}$ .

\*2: For suffix B0 model, its charge current default setting is 4A.

\*3: When the **External Battery Type** is set as **Standard battery pack**, you need to configure the **Part Number** and the **Quantity** of the standard battery pack(s).

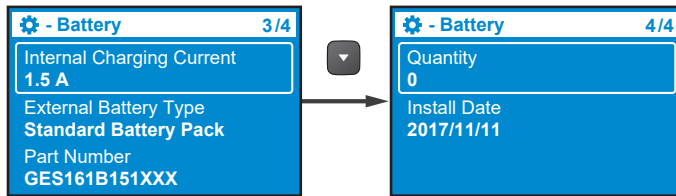

When the **External Battery Type** is set as **Customer own batt. pack**, the **Part Number** and **Quantity** will be changed accordingly to **Battery Voltage** and **Total Capacity**.

• **General**

Setup Item	Selectable Value	Default Value
<b>Language</b>	English/ 简体中文 / 繁體中文 / ...	English
<b>Audible Alarm</b>	Enable/ Disable	Enable
<b>LCD Back Light</b>	Always On/ Auto Off	Auto off
<b>Date</b>	YYYY/MM/DD	
<b>Time</b>	HH:MM:SS	

- **Outlet Control**

Setup Item	Selectable Values- Level 2	Selectable Values- Level 3	Default Value
<b>Outlets - Group 1</b>	Output Reboot Duration	Disable/ 5/ 6/ .../ 300 seconds (per step: 1sec)	Disable
	Load Bank Runtime Limitation	Disable/ 1/ 2/.../ 240mins (per step: 1min)	Disable

- **Dry Contact Setting**

Setup items	Selectable value	Default value
<b>Dry Contact 1 - Input</b>	Option 1*1: Disable/ ROO/ RPO/ Remote shutdown/ Forced bypass/ On generator Option 2: 0-999s (per step: 1 sec) Option 3: Normal open/Normal close	Disable
<b>Dry Contact 2 - Output</b>	Disable/ On bat/ Low bat/ Bat fault/ Bypass/ UPS OK/ Load protected/ Load powered/ General alarm/ Overload alarm	On batt.
<b>Dry Contact 3 - Output</b>	Disable/ On bat/ Low bat/ Bat fault/ Bypass/ UPS OK/ Load protected/ Load powered/ General alarm/ Overload alarm	Low batt.
<b>Dry Contact 4 - Output</b>	Disable/ On bat/ Low bat/ Bat fault/ Bypass/ UPS OK/ Load protected/ Load powered/ General alarm/ Overload alarm	General alarm
<b>Remote Control</b>	Option 1: REPO/ ROO	REPO/ NO
	Option 2: Normally open/ Normally closed (For REPO)	







**NOTE :**

\*1: For detailed information about option 1, please contact service personnel.

• **Component Life Prediction**

Setup Item	Selectable Value	Default Value
Fan Life Prediction	No/ Yes	No

**9.2.3 Control Menu**

In **Main Menu**, after selecting  **Control**, press the button  to enter the **Control Menu**.

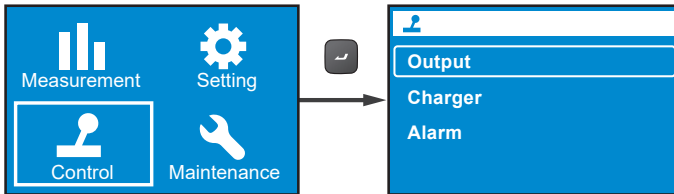

The **Control Menu** provides commands for enabling specific UPS functions. Please refer to the table below for the setup items and selectable values.

LEVEL 1	LEVEL 2	LEVEL 3	LEVEL 4	LEVEL 5
Control	Output	Outlet Group 1	Output Reboot Immediately	Yes/ No
			Output Reboot With Delay	Yes/ No
		Bypass* <sup>1</sup>	Go into Bypass	Yes/ No
			Go out of Bypass	Yes/ No
	Charger	Execute Boost Charge	Yes/ No	
	Alarm	Clear Prediction Warning* <sup>2</sup>	Yes/ No	



**NOTE:**

- \*1: The item **Bypass** will be hidden if you set the **Standby Mode** as **Bypass Output**. To set up **Bypass Output**, please go to  → **Output** → **Standby Mode** → **Bypass Output**.
- \*2: The item **Delay Alarm Again** under **Control** → **Alarm** → **Clear Prediction Warning** can be set from 1 week to 52 weeks.

For example, if you need the UPS to reboot the output immediately, please go to



→ **Output** → **Outlet Group 1** → **Output Reboot Immediately** → **Yes**.

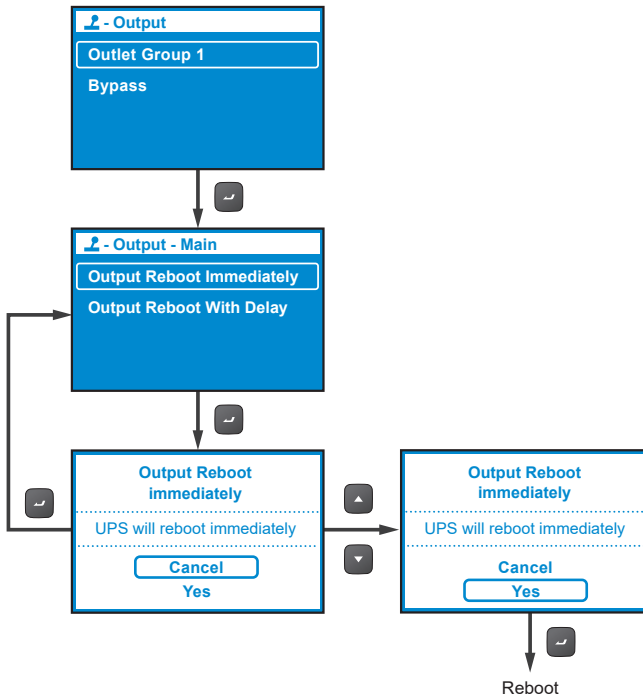

## 9.2.4 Maintenance Menu

In **Main Menu**, after selecting  , press the button  to enter the **Maintenance Menu**.

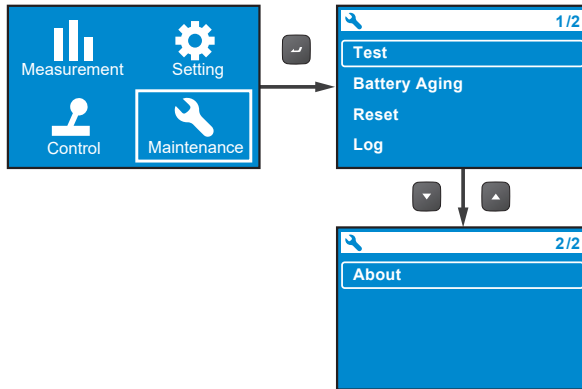

The **Maintenance Menu** provides commands for enabling UPS maintenance functions. It also provides event logs and UPS identification. Please refer to the table below for the setup items and selectable values.

LEVEL 1	LEVEL 2	LEVEL 3	LEVEL 4	LEVEL 5
Maintenance	Test	Start Battery Test	Test in Progress...	Test Result: Pass
				Test Result: Fail
				Test Result: Not Finished
		Deep Discharge Test	Test in Progress...	Test Result: Pass
				Test Result: Fail
				Test Result: Not Finished
		Local Output Dry Contact Test	Dry Contact 2	Dry Contact 2 In Progress...
			Dry Contact 3	Dry Contact 3 In Progress...
			Dry Contact 4	Dry Contact 4 In Progress...
	Battery Aging	Create Discharging Reference	Yes/ Cancel	
		Battery Discharging History	Item, Output power, Total discharging time	Date/ Time, Average load (W), Actual discharging time, Estimated remaining time, Total discharging time
	Reset	Reset Power Usage Calculator	Yes/ Cancel	
		Restore Factory Setting	Yes/ Cancel	

LEVEL 1	LEVEL 2	LEVEL 3	LEVEL 4	LEVEL 5
Maintenance	Log	Event List	Description, Event code YYYY/MM/DD HH:MM:SS	Error Description
		Clear Log	Yes/Cancel	
	About	Model Name: RT-5K		
		UPS - Part No. UPS502R2RT0B035		
		UPS - Serial No. 1BA0150001		
		UPS - Manufacture Date YYYY-MM		
		PS Firmware – Version 06AR004		
		Battery Summary: Installed YYYY/MM/ DD Replace YYYY/MM/ DD		

For example, if you need to execute a battery test, please go to **Test** → **Start Battery Test** → **Test In Progress...** → **Test Result: Pass (or Fail)**.

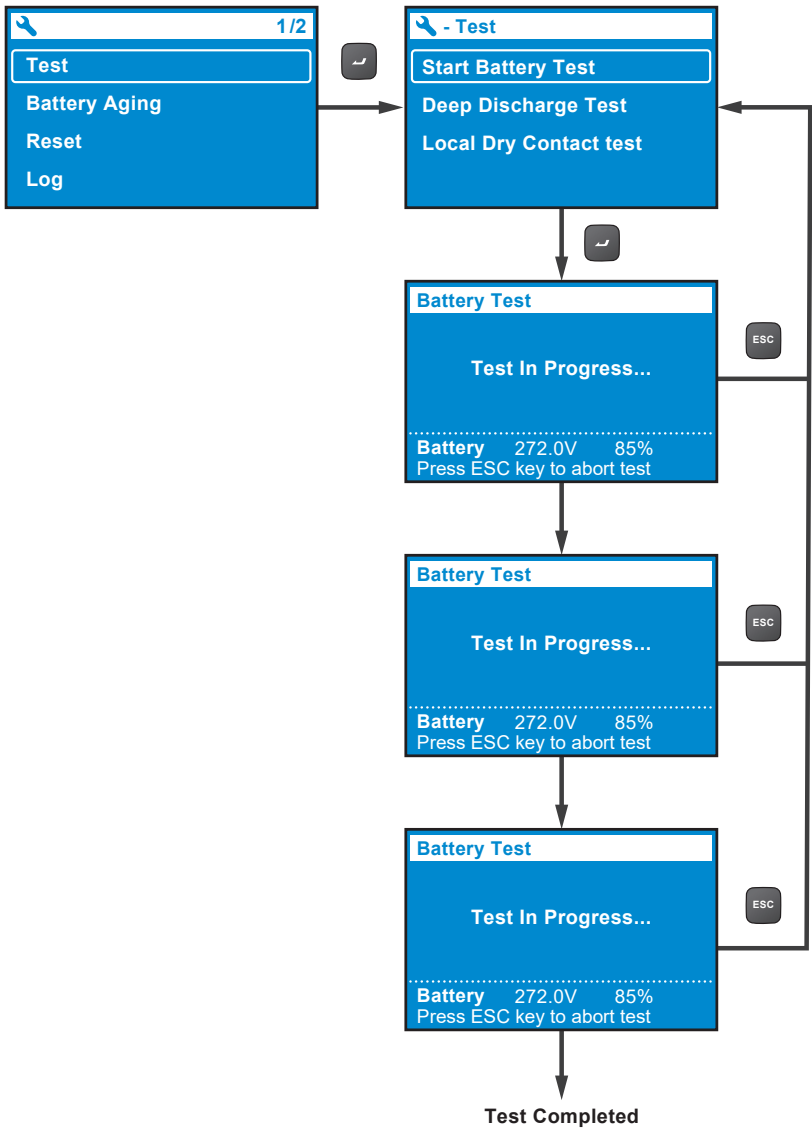

Once the test is completed, the test result will be shown as follows.

- A. Test Result\_ Fail: The alarm icon will show in the left bottom of the LCD display.
- B. Tests Result\_ Pass: No alarm icon occurs, and the UPS runs normally.

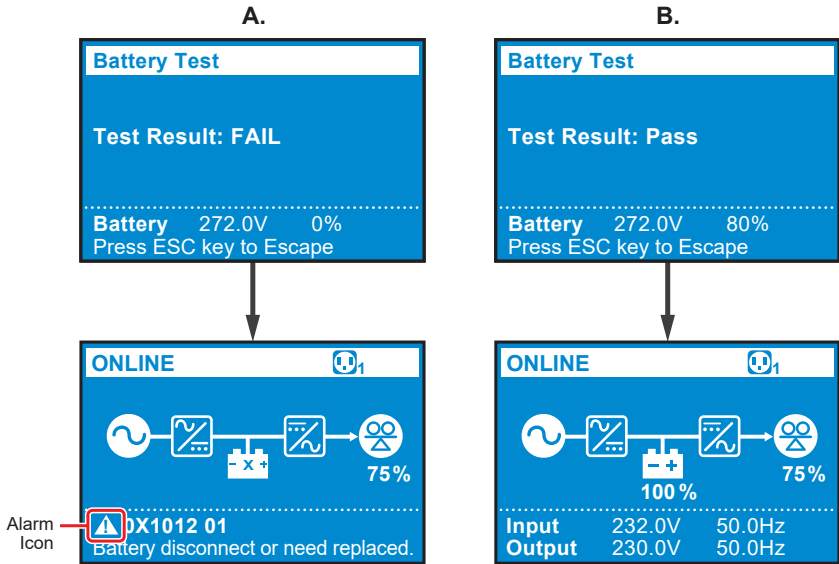

## Chapter 10 : Optional Accessories

There are several optional accessories available for this RT series UPS. Please refer to the table below for the optional accessories and their functions.

No.	Item	Function
1	Dust Filter(s)	Prevent(s) dust from entering into the UPS to ensure UPS reliability and to prolong product life.
2	Mini SNMP IPv6 Card	Monitors and controls the status of the UPS via a network system.
3	Mini Relay I/O Card	Increases the quantity of dry contacts.
4	Mini MODBUS Card	Lets the UPS have MODBUS communication function.
5	External Battery Pack Cable Extension Kit (includes 2 annular terminals and 2 butt joint connectors)	Use the external battery pack cable extension kit to extend its range.
6	Delta Lead-acid Battery Pack	Provides lead-acid batteries to let the UPS continue supplying power to its connected loads when a power outage occurs.
7	Delta Lithium-ion Battery Pack	Provides lithium-ion batteries to let the UPS continue supplying power to its connected loads when a power outage occurs.
8	Maintenance Bypass Box (Single/ Parallel)	Lets the UPS continue supplying power to its connected loads when the UPS is under maintenance.
9	Rail Kit	Fixes the UPS in a rack cabinet firmly.



### NOTE :

1. For detailed installation and operation of any accessory mentioned above, please refer to the **Quick Guide, User Guide, or Installation & Operation Guide** included in the package of the relevant optional accessory.
2. If you want to buy any accessory mentioned above, please contact your local dealer or customer service.



## Chapter 11 : Troubleshooting

- When a problem occurs, please check if following situations exist before contacting Delta service personnel:
  - Is the main input voltage present?
- Please have the following information ready if you would like to contact the Delta service personnel:
  - Unit information including model, serial number, etc.
  - An exact description of the problem. The more detailed description of the problem, the better.
- When you see the following problems occur, please refer to the solutions shown below.

Error Code	Alarm Message	Possible Cause	Solution
<b>0X61C1</b>	Input Fuse Open	The input fuse is melted or the input relay is open.	Please contact service personnel.
<b>0X60C0</b>	PFC Soft Start Fail	The UPS has an internal fault.	Please contact service personnel.
<b>0X6221</b> <b>0X6241</b>	DC Bus Over Shutdown	1. The output has capacitive or inductive loads. 2. The UPS has an internal fault.	1. Remove the capacitive or inductive loads. 2. Please contact service personnel.
<b>0X62A0</b> <b>0X62C0</b>	DC Bus Under Shutdown	The UPS has an internal fault.	Please contact service personnel.
<b>0X1200</b>	INV Volt Abnormal	The UPS has an internal fault.	Please contact service personnel.

Error Code	Alarm Message	Possible Cause	Solution
0X1101	Output Overload Shutdown	The UPS is over-loaded.	Check the power consumption of the loads, and remove the unnecessary loads.
0XA000	Charger Fault	The UPS has an internal fault.	Please contact service personnel.
0X8106	INV IGBT Over Heat Shutdown	<ol style="list-style-type: none"> <li>1. The vents are blocked.</li> <li>2. The UPS has an internal fault.</li> </ol>	<ol style="list-style-type: none"> <li>1. Check whether the vents are blocked.</li> <li>2. Contact service personnel.</li> </ol>
0X6100	PFC Over Heat Shutdown	<ol style="list-style-type: none"> <li>1. The vents are blocked.</li> <li>2. The UPS has an internal fault.</li> </ol>	<ol style="list-style-type: none"> <li>1. Check whether the vents are blocked.</li> <li>2. Contact service personnel.</li> </ol>
0X1003	Battery Disconnected	<ol style="list-style-type: none"> <li>1. The UPS is not properly connected to the external battery pack(s).</li> <li>2. The battery/ batteries is (are) damaged.</li> </ol>	<ol style="list-style-type: none"> <li>1. Check whether the UPS is properly connected to the external battery pack(s).</li> <li>2. Contact service personnel.</li> </ol>



**NOTE :**

If all possible causes are eliminated but the alarm still appears, please contact your local dealer or customer service.

## Chapter 12 : Maintenance

### 12.1 UPS

- **UPS Cleaning**

Regularly clean the UPS, especially the slits and openings, to ensure that the air freely flows into the UPS to avoid overheating. If necessary, use an air-gun to clean the slits and openings to prevent any object from blocking or covering these areas.

- **UPS Regular Inspection**

Regularly check the UPS every half year and inspect:

1. Whether the UPS, LEDs, and alarm function are operating normally.
2. Whether battery voltage is normal. If battery voltage is too high or too low, find the root cause.

### 12.2 Batteries

The RT series UPS uses lead-acid or lithium-ion batteries. Though the typical battery life cycle is 3~5 years, the battery life depends on the temperature, usage, and charging/ discharging frequency. High temperature environments and high charging/ discharging frequency will quickly shorten the battery life. The batteries do not require user maintenance; however, they should be checked periodically. Please follow the suggestions below to ensure a normal battery lifetime.

- Keep the usage temperature at 20°C ~ 25°C.
- Idle batteries must be fully recharged every three months if the UPS needs to be stored for an extended period of time. Please fully charge the batteries until the battery capacity percentage shown on the UPS's LCD is 100% ( 100%).



**NOTE :**

If the UPS's batteries need to be replaced, please contact qualified service personnel. During battery replacement, the loads connected to the UPS will not be protected if input power fails.

## 12.3 Fans

Higher temperatures shorten fan life. When the UPS is running, please periodically check if each fan works normally and make sure if the ventilation air can move freely around and through the UPS. If not, contact service personnel to replace the fans.



**NOTE:**

Please ask your local dealer or customer service for more maintenance information. Do not perform maintenance if you are not trained for it.

## Appendix 1 : Technical Specifications

Model		RT-5K	RT-6K	RT-8K	RT-10K
Power Rating		5kVA/5kW	6kVA/6kW	8kVA/8kW	10kVA/10kW
Waveform		Pure Sinewave			
Input	Nominal Voltage	200/208/220/230/240 Vac			
	Voltage Range	175 ~ 280Vac (100% load); 100 ~ 175Vac (50% ~ 100% load)			
	Frequency	50/60 Hz $\pm$ 10 Hz			
	Power Factor	0.99 (full load)			
	iTHD	< 3% (linear load)			
	Connection	Terminal Block			
Output	Power Factor	Unity			
	Voltage	200/208/220/230/240 Vac			
	Voltage Regulation	$\pm$ 1% (linear load)			
	Frequency	50/60 Hz $\pm$ 0.05 Hz			
	vTHD	<2% (linear load)			
	Overload Capacity	< 105%: continuous; 105% ~ 125%: 2 minutes; 125% ~ 150%: 30 seconds; >150%, 500 ms			
	Cress Factor	3:1			
	Connection	Terminal Block $\times$ 2			
Battery & Charger	Battery Voltage	144* <sup>1</sup> , 192 ~ 264 Vdc adjustable Default: 192 Vdc		144* <sup>1</sup> , 192 ~ 264 Vdc adjustable Default: 240 Vdc	
	Battery Type	Lead-acid battery or Lithium-ion battery			
	Charging Current	Up to 8A			

Model		RT-5K	RT-6K	RT-8K	RT-10K
Efficiency	Online Mode	Up to 95.5%			
	ECO Mode	Up to 99%			
Audible Noise		48 dBA		50 dBA	
Display		LED indicators and LCD display			
Communication Interfaces		MINI Slot × 1, RS-232 Port × 1, USB Port × 1, Parallel Port × 2, REPO/ROO × 1, RS-485 Port × 1, Dry Contact × 4			
Physical	Dimensions (W × D × H)	440 × 430/ 508* <sup>2</sup> × 88.2 mm (17.3 × 16.9/ 20 × 3.5 inch)		440 × 565/ 643* <sup>2</sup> × 88.2 mm (17.3 × 22.2/ 25.3 × 3.5 inch)	
	Weight	10.9 kg (24.03 lb)	10.9 kg (24.03 lb)	15.2 kg (33.51 lb)	15.2 kg (33.51 lb)
Environment	Operating Altitude	0 ~ 3000 m (0 ~ 10000 ft); 0 ~ 1000 m (0 ~ 3300 ft) (without derating)			
	Operating Temperature	0°C ~ 55°C* <sup>3</sup> (32 ~ 131°F)			
	Storage Temperature	-15°C ~ 55°C (-59 ~ 131°F)			
	Relative Humidity	5% ~ 95% (non-condensing)			



**NOTE:**

- \*<sup>1</sup>: The UPS needs to be de-rated to 70% of its capacity.
- \*<sup>2</sup>: The latter value of UPS's depth is measured including its terminal block.
- \*<sup>3</sup>: When the operating temperature is at 40 ~ 55°C (104 ~ 131°F), the UPS will be de-rated to 75% of its capacity.
- Please refer to the rating label for the safety rating.
- All specifications are subject to change without prior notice.

## Appendix 2 : Warranty

Seller warrants this product, if used in accordance with all applicable instructions, to be free from original defects in material and workmanship within the warranty period. If the product has any failure problem within the warranty period, Seller will repair or replace the product at its sole discretion according to the failure situation.

This warranty does not apply to normal wear or to damage resulting from improper installation, operation, usage, maintenance or irresistible force (i.e. war, fire, natural disaster, etc.), and this warranty also expressly excludes all incidental and consequential damages.

Maintenance service for a fee is provided for any damage out of the warranty period. If any maintenance is required, please directly contact the supplier or Seller.

**WARNING:**

The individual user should take care to determine prior to use whether the environment and the load characteristic are suitable, adequate or safe for the installation and the usage of this product. The User Manual must be carefully followed. Seller makes no representation or warranty as to the suitability or fitness of this product for any specific application.

No. 501327240102

Version : V 1.2

Release Date :2019\_07\_02



5013272401